



ELÉTRICO

BOCAL SOQUETE E 27 250V

CÓD.	DESCRIÇÃO	EMBAL.
3891	C/ RABICHO	C/50UN
3890	S/ RABICHO	C/50UN



FIXADOR DE FIO

CÓD.	DESCRIÇÃO	EMBAL.
	8 MM	
3883	CIRCULAR	C/50UN
3884	RETANGULAR	C/50UN
	10 MM	
3885	CIRCULAR	C/50UN
3884	RETANGULAR	C/50UN



BOCAL SOQUETE E-27

CÓD.	DESCRIÇÃO	EMBAL.
3892	PORCELANA	C/50UN



FITA ISOLANTE

CÓD.	DESCRIÇÃO	EMBAL.
3887	5M	C/10UN
3888	10M	C/10UN
3889	20M	C/10UN



FITA ISOLANTE AUTO FUSÃO

CÓD.	DESCRIÇÃO	EMBAL.
9658	2 M	C/10UN
9138	5 M	C/10UN
9139	10 M	C/10UN



PINO EXT. POLARIZ. PORCELANA 380V

CÓD.	DESCRIÇÃO	EMBAL.
9141	30A 2P	C/10UN
9142	20A 3P	C/10UN
9143	30A 3P	C/10UN



BUCHA FIXAÇÃO C/ ANEL NYLON

CÓD.	DESCRIÇÃO	EMBAL.
9135	06 mm	C/100UN
9136	08 mm	C/100UN



BOCAL SOQ. E-27 ADAPT. 4A 250V

CÓD.	DESCRIÇÃO	EMBAL.
9140	PLUG - TERMO	C/50UN



MULTIMETRO DIGITAL

CÓD.	DESCRIÇÃO	EMBAL.
9802	10A	----





DECORLUX®

DISJUNTOR MINI TRIPOLAR CURVA 230-400V CURVA



CÓD.	DESCRIÇÃO	EMBAL.
10228	100A	C/ 04
10229	80A	C/ 04

MULTÍMETRO 750V DIGITAL C/ ALICATE AMPERIMETRO



CÓD.	DESCRIÇÃO	EMBAL.
10230	1000 A	C/ 01

BOCAL SOQ. E27 BRANCO



CÓD.	DESCRIÇÃO	EMBAL.
10231	C/ RABICHO	C/ 50



BOCAL SOQ. E40 P/ E27 PORCELANA C/ ADAPT.



CÓD.	DESCRIÇÃO	EMBAL.
10233	BRANCO	C/ 20

BOCAL SOQ. E27 P/ E40 PORCELANA C/ ADAPT.



CÓD.	DESCRIÇÃO	EMBAL.
10232	BRANCO	C/ 10

TOMADA EXT. POLARIZA PORCELANA 2 POLOS 380V



CÓD.	DESCRIÇÃO	EMBAL.
9661	20A	C/10UN
9144	30A	C/10UN

SENSOR DE PRESENÇA E27 100-240V



CÓD.	DESCRIÇÃO	EMBAL.
9660	C/ BASE	----

TOMADA EXT. POLARIZA PORCELANA 3 POLOS 380V



CÓD.	DESCRIÇÃO	EMBAL.
9145	20A	C/10UN
9146	30A	C/10UN



R. São José, 508 - Centro - Areial-PB
(83) 3368-1121
ajalesatmc@hotmail.com



DECORLUX®

**TERMINAL ANEL M3
PRE ISOLANTE 1,5-
2,5mm AZ**

CÓD.	DESCRIÇÃO	EMBAL.
10234	27 A	C/ 50



**TERMINAL ANEL M3
PRE ISOLANTE 4,0-
6,0mm AM.**

CÓD.	DESCRIÇÃO	EMBAL.
10235	48A	C/ 50
15204	48A	C/ 50



**TERMINAL DE
COMPRESSÃO**

CÓD.	DESCRIÇÃO	EMBAL.
10236	16MM 68A	C/ 50
10237	25MM 89A	C/ 50
10239	35MM 111A	C/ 50
10238	50MM 134A	C/ 50



**TERMINAL GARFO M3
PRE ISOLANTE 1,5-
2,5 mm 3,7MM AZ**

CÓD.	DESCRIÇÃO	EMBAL.
10240	27 A	C/ 50



**TERMINAL GARFO M4
PRE ISOLANTE 4,0-
6,0 mm AM.**

CÓD.	DESCRIÇÃO	EMBAL.
10241	48 A	C/ 50



**TERMINAL PINO
PRE ISOLANTE M4
25,5mm 4,0/6,0mm
AM.**

CÓD.	DESCRIÇÃO	EMBAL.
10242	48 A	C/ 50



**TERMINAL LUVA M4
FEMEA PRE ISOLANTE
4,0-6,0 mm AM**

CÓD.	DESCRIÇÃO	EMBAL.
11865	24A	C/ 50



FITA ISOLANTE



CÓD.	COR	EMBAL.
----	5 MT	----
10376	AMARELA	C/10 UN
10377	AZUL	C/10 UN
10378	BRANCA	C/10 UN
10379	CINZA	C/10 UN
10380	VERDE	C/10 UN
10381	VERMELHA	C/10 UN

	10 MT	
10382	AMARELA	C/10 UN
10383	AZUL	C/10 UN
10384	CINZA	C/10 UN
10385	VERDE	C/10 UN

**SENSOR DE
PRESENÇA S/ CHAVE
ATÉ 9M 100-240V**

CÓD.	DESCRIÇÃO	EMBAL.
10386	4X2	C/ 20



R. São José, 508 - Centro - Areial-PB
(83) 3368-1121
ajalesatmc@hotmail.com

HASTE 8,00mm P/ ATERRAMENTO



CÓD.	DESCRIÇÃO	EMBAL.
14092	1000 MM	C/10
14093	1200 MM	C/10
14094	1500 MM	C/10
14095	2000 MM	C/10
14096	2400 MM	C/10

HASTE 9,53mm P/ ATERRAMENTO

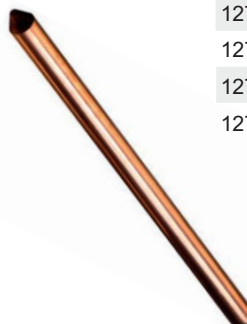

CÓD.	DESCRIÇÃO	EMBAL.
12755	1000 MM	C/10
12756	1200 MM	C/10
12757	1500 MM	C/10
12758	2000 MM	C/10
12759	2400 MM	C/10



HASTE COBREADO 3/8X9,53



CÓD.	DESCRIÇÃO	EMBAL.
13005	1,00 MT	PCT C/10
13006	1,20 MT	PCT C/10
13007	1,50 MT	PCT C/10
13008	2,00 MT	PCT C/10
13009	2,40 MT	PCT C/10

INCOBRAME

INDUSPLAST

GRAMPO GTDU P/ ATERRAMENTO C/ PARAF. P/ HASTE DE 12MM



CÓD.	DESCRIÇÃO	EMBAL.
14099	U - 1/4"	C/ 25

TUBO ELETRODUTO ROSCAVEL PVC



CÓD.	DESCRIÇÃO	EMBAL.
14726	3/4"	C/30
14727	1"	C/20

**CENTRO DISTRIB.
TAMPA BRANCA
S/ BARRAMENTO CB**



CÓD.	DESCRIÇÃO	EMBAL.
10922	3/4 DISJ.	C/ 08
10923	6/8 DISJ.	C/ 08
10924	12/16 DISJ.	C/ 04

**CENTRO DISTRIB.
TAMPA BRANCA
C/ BARRAMENTO CB**



CÓD.	DESCRIÇÃO	EMBAL.
14859	6/8 DISJ.	C/ 08



**CENTRO DISTRIB.
TAMPA TRANSP.
S/ BARRAMENTO CB**



CÓD.	DESCRIÇÃO	EMBAL.
10925	3/4 DISJ.	C/ 08
10926	6/8 DISJ.	C/ 08
10927	12/16 DISJ.	C/ 04

**BARRAMENTO
MONOFASICO
DIN 80A 440V**

CÓD.	DESCRIÇÃO	EMBAL.
14860	8 LIG.	C/ 01
14862	12 LIG.	C/ 01

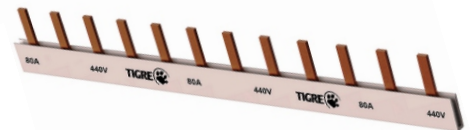

**BARRAMENTO
TRIFASICO
DIN 80A 440V**

CÓD.	DESCRIÇÃO	EMBAL.
14861	9 LIG.	C/ 01
14863	12 LIG.	C/ 01

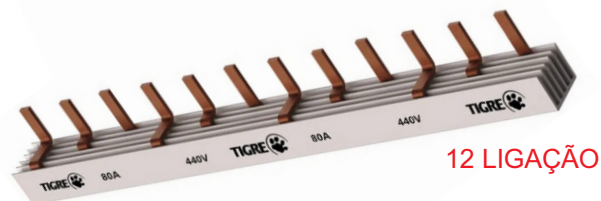
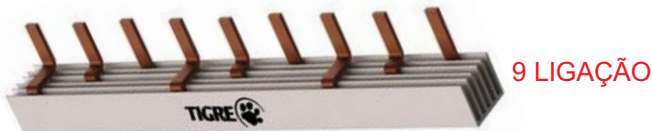

**CURVA ELETRODUTO
90° ROSCAVEL**

CÓD.	DESCRIÇÃO	EMBAL.
13078	3/4"	C/ 40
13079	1"	C/ 12



**CORRUGADO
ELETRODUTO
PVC**

CÓD.	DESCRIÇÃO	EMBAL.
10920	20MM (1/2")	C/ 50MT
10921	25MM (3/4")	C/ 50MT



**LUVA ELETRODUTO
ROSCAVEL**

CÓD.	DESCRIÇÃO	EMBAL.
13080	3/4"	C/ 50
14291	1"	C/ 40



TUBO ELETRODUTO ROSCAVEL ANTI-CHAMAS

CÓD.	DESCRIÇÃO	EMBAL.
13070	3/4"	C/ 20



SUPORTE P/ LAJE OCTAGONAL

CÓD.	DESCRIÇÃO	EMBAL.
13077	4X4	C/ 21



ROSTAND

PONTALETE GALV. C/ ROLDANA CANO 1.1/2"

CÓD.	DESCRIÇÃO	EMBAL.
8601	1,50M	C/05UN
8600	3,00M	C/03UN
8602	6,00M	-----



ARANDELA LUMINARIA DE FIBRA P/ POSTE

CÓD.	DESCRIÇÃO	EMBAL.
8583	GRANDE	-----
8616	PEQUENA	-----



CABEÇOTE ALUMINIO

CÓD.	DESCRIÇÃO	EMBAL.
10254	3/4"	----



STECK

CANALETA PVC ADESIVADA BR.

CÓD.	DESCRIÇÃO	EMBAL.
12231	20X10	CX C/ 50



DISJUNTOR BR MONOPOLAR Sd61 CURVA

CÓD.	DESCRIÇÃO	EMBAL.
12080	C10A	CX C/ 12
12081	C16A	CX C/ 12
12082	C20A	CX C/ 12
12083	C25A	CX C/ 12
12084	C32A	CX C/ 12





CAIXA MEDIDOR MONOF ENERGISA PADRÃO NOVO

CÓD.DESCRICÃO EMBAL.
6712 - C/06UN



CAIXA MEDIDOR TRIFASICO

CÓD.DESCRICÃO EMBAL.
5629 - C/02UN



BARRAMENTO FASE MONOFASICO 63A

CÓD. DESCRICÃO EMBAL.
15205 21 CM - 6 DISJ ----
14478 14 CM - 8 DISJ -----
14479 21CM - 12 DISJ -----

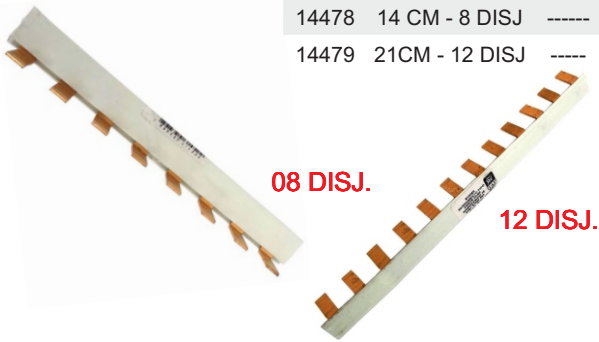

08 DISJ.

12 DISJ.

CENTRO DISTRIBUIÇÃO FUMÊ

CÓD.DESCRICÃO EMBAL.
6380 P/ 3 ou 4 Disj. ----
6379 P/ 6 ou 8 Disj. -----
6378 P/ 12 ou 16 Disj. -----



6380

Centro de distribuição para até 3 disjuntores NEMA ou 4 disjuntores DIN



6379

Centro de distribuição para até 6 disjuntores NEMA ou 8 disjuntores DIN



6378

Centro de distribuição para até 12 disjuntores NEMA ou 16 disjuntores DIN

CENTRO DISTRIBUIÇÃO BRANCO

CÓD.DESCRICÃO EMBAL.
8543 P/ 1 DISJ. ----



CENTRO DISTRIBUIÇÃO TAMPA BRANCA

CÓD. DESCRICÃO EMBAL.
14371 P/3 ou 4 Disj. ----
14372 P/6 ou 8 Disj. -----
14373 P/12 ou 16 Disj. -----

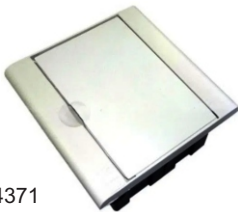

14371

Centro de distribuição para até 3 disjuntores NEMA ou 4 disjuntores DIN



14372

Centro de distribuição para até 6 disjuntores NEMA ou 8 disjuntores DIN



14373

Centro de distribuição para até 12 disjuntores NEMA ou 16 disjuntores DIN

CENTRO DISTRIBUIÇÃO P/ 8 DISJ. DIN PRETO

CÓD. DESCRICÃO EMBAL.
14835 TAMPA BR ----
14836 TAMPA FUME -----



R. São José, 508 - Centro - Areal-PB
(83) 3368-1121
ajalesatmc@hotmail.com

LAMP. FLUOR. COMP. U 6400K



CÓD.DESCRICÃO EMBAL.

7312	15W	C/10UN
7546	20W	C/10UN
7313	25W	C/10UN
7630	30W	C/10UN

LÂMPADA MISTA BOCAL E27 220V



CÓD.DESCRICÃO EMBAL.

6343	160W	C/40UN
6344	250W	C/20UN

LÂMPADA SUPER LED A60 6500K BIVOLT



CÓD.DESCRICÃO EMBAL.

6676	10W	C/10UN
------	-----	--------

LANTERNA



CÓD.DESCRICÃO EMBAL.

6184	5 LEDS	----
6185	11 LEDS	----



LUMINÁRIA TARTARUGA



CÓD.DESCRICÃO EMBAL.

7770	BRANCA	----
7771	PRETA	----

LUMINÁRIA LED DE EMERGÊNCIA



CÓD.DESCRICÃO EMBAL.

7769	-	----
------	---	------

MULTIMETRO DIGITAL



CÓD.DESCRICÃO EMBAL.

7245	BATERIA	----
------	---------	------

PINO POLARIZADO DE PORCELANA 2 POLOS



CÓD.DESCRICÃO EMBAL.

7772	20A	----
7775	30A	----

PINO POLARIZADO DE PORCELANA 3 POLOS



CÓD.DESCRICÃO EMBAL.

7773	20A	----
6115	30A	----

TOMADA POLARIZADO DE PORCELANA 2 POLOS

CÓD.	DESCRIÇÃO	EMBAL.
7782	20A	C/10UN
7776	30A	C/10UN



TOMADA POLARIZADO DE PORCELANA 3 POLOS

CÓD.	DESCRIÇÃO	EMBAL.
7774	20A	C/10UN
6116	30A	C/10UN



FITA ISOLANTE PRETO - TUBO

CÓD.	DESCRIÇÃO	EMBAL.
6194	05 M	C/10UN
6106	20 M	C/10UN



FITA AUTO FUSÃO

CÓD.	DESCRIÇÃO	EMBAL.
7766	02 M	C/10UN
7767	05 M	C/10UN
7768	10 M	C/10UN



FITA ISOLANTE PRETA - POTE

CÓD.	DESCRIÇÃO	EMBAL.
6107	05 m	C/50UN
6196	10 m	C/35UN
6108	20 m	C/25UN



FITA ISOLANTE 10 MT - TUBO

CÓD.	DESCRIÇÃO	EMBAL.
7763	AZUL	C/10UN
7762	BRANCO	C/10UN
6195	PRETA	C/10UN
7764	VERDE	C/10UN
7765	VERMELHA	C/10UN
8570	AMARELO	C/10UN



PLUG MODULAR 8P8C RJ45

CÓD.	DESCRIÇÃO	EMBAL.
6175	-	C/100UN
8572	-	C/50UN



CONECTOR COAXIAL TIPO ROSCA Rg59

CÓD.	DESCRIÇÃO	EMBAL.
12852	Rg59	C/20
12853	Rg6	C/20



CONECTOR COAX. DE COMPRESSAO RG59

CÓD.	DESCRIÇÃO	EMBAL.
9338	VERMELHO	C/20



CONECTOR COAX. DE COMPRESSAO RG6

CÓD. DESCRIÇÃO EMBAL.
9337 AZUL C/20



BOCAL ADAPTADOR PORCELANA E-27 FX 04

CÓD. DESCRIÇÃO EMBAL.
9297 P/ E-40 -----



DIVISOR BAIXA 5-900MHZ

CÓD. DESCRIÇÃO EMBAL.
9340 4 SAIDA C/10



EMENDA FEMEA PARA COAXIAL

CÓD. DESCRIÇÃO EMBAL.
9339 UNIVERSAL C/20



EMENDA FEMEA COAXIAL UNIVERSAL

CÓD. DESCRIÇÃO EMBAL.
11548 TIPO "T" PC C/20



ROLDANA DE PORCELANA

CÓD. DESCRIÇÃO EMBAL.
9342 67X72MM CX C/10



LAMPADA LED BULBO BIVOLT 7W

CÓD.	DESCRIÇÃO	EMBAL.
10277	AZUL	----
10278	VERDE	----
10279	VERMELHO	----
10280	AMARELO	----



PLAFON PLASTICO C- BOCAL E-27 DE PORCELANA

CÓD. DESCRIÇÃO EMBAL.
9341 BRANCO ----



BOCAL SOQUETE TERMOPLASTICO

CÓD.	DESCRIÇÃO	EMBAL.
7322	C/ RABICHO	CX C/50
7323	S/ RABICHO	CX C/50



CHAVE TESTE

CÓD. DESCRIÇÃO EMBAL.
7246 100-500V C/12



FIO BICOLOR

CÓD.	DESCRIÇÃO	EMBAL.
8743	0,75mm 2x18 awg	C/100 MT
8744	1,00mm 2x16 AWG	C/100 MT
8745	1,50mm 2x14 AWG	C/100 MT



CABO COAXIAL RG59 P/ ANTENA

CÓD.	DESCRIÇÃO	EMBAL.
8576	47%	RL C/100MT
8577	67%	RL C/100MT



TUBO ELETRODUTO ROSCÁVEL

CÓD.	BITOLA	EMBAL.
8612	3/4"	C/10



CAIXA DE LUZ

CÓD.	BITOLA	EMBAL.
AMARELO		
5296	4X2	C/12UN
6105	4X4	C/12UN
PRETO		
9334	4X2	C/12UN
9335	4X4	C/12UN



MANGUEIRA P/ GÁS

CÓD.	DESCRIÇÃO	EMBAL.
5063	1,00 mt	C/12UN
7400	1,20 mt	C/12UN



MANG. P/ FOGÃO INDUSTRIAL 5/16 C/ VALVULA

CÓD.	DESCRIÇÃO	EMBAL.
5300	1,00 mt	C/12UN



CANALETA C/ FITA ADESIVA 20x10x200MM

CÓD.	DESCRIÇÃO	EMBAL.
5058	BRANCO	C/20UN
5086	MARFIM	C/20UN



**LUMINARIA TIPO
TARTARUGA 60W
250V**



CÓD.	DESCRIÇÃO	EMBAL.
7076	BRANCO	C/08
7077	PRETO	C/08

**PINO FÊMEA BR
250V**



CÓD.	DESCRIÇÃO	EMBAL.
7789	10A	PT C/60

**PINO MACHO C/
PRENSA CABO 2P
250V**



CÓD.	DESCRIÇÃO	EMBAL.
8693	10A	C/10
8882	10A	PT C/60

**TOMADA EXTERNA
RED. BIP 2P+T**



CÓD.	DESCRIÇÃO	EMBAL.
8694	10A	POTE C/20
12127	10A	PCT C/10

**PLACA CEGA C/
SUPORTE**



CÓD.	DESCRIÇÃO	C/20	EMBAL.
8707	4X2		

**PLAFON C/ RECPT
100W 250V**



CÓD.	DESCRIÇÃO	EMBAL.
8695	BRANCO	----
7079	PRETO	----

CAIXA P/ CANALETA



CÓD.	DESCRIÇÃO	EMBAL.
14842	4X2	C/10

**INTERRUPTOR
REDONDO**



CÓD.	DESCRIÇÃO	EMBAL.
7075	CINZA	PT C/40
9891	CINZA	SC C/10

**CAMPAINHA DIM DOM
220V**

CÓD.	DESCRIÇÃO	EMBAL.
7080	C/ FIO	C/10UN



CIGARRA BIVOLT

CÓD.	DESCRIÇÃO	EMBAL.
7028	127/220V	C/10



**CANALETA PVC
C/ FITA DUPLA FACE
20X10X200mm BR**

CÓD.	DESCRIÇÃO	EMBAL.
8700	C/ DIVISORIA	C/25
9874	S/ DIVISORIA	C/25



**INTERRUPTOR
MEIO CORDÃO
SIMPLES 250V**

CÓD.	DESCRIÇÃO	EMBAL.
9547	6A	C/10



**EXTENSÃO COMPACTA
C/ CORDÃO PARAL.
250V 10A**

CÓD.	DESCRIÇÃO	EMBAL.
9867	3M	C/10
9868	5M	C/10
9862	10M	C/10



**EXTENSÃO COMPACTA
C/ CABO PP CH 3VIAS
250V 10A**

CÓD.	DESCRIÇÃO	EMBAL.
9869	3M	C/10
9866	5M	C/10
9861	10M	C/10



**CX DISJUNTOR CDT +
TOMADA 20A 250V**

CÓD.	DESCRIÇÃO	EMBAL.
9863	20A	C/08



**QUADRO DIST. 1/2
DISJ. NEMA/DIN C/
LENTE**

CÓD.	DESCRIÇÃO	EMBAL.
5300	BRANCO	C/12



LINHA: STYLUS

**INTERRUPTOR
PARALELA 250V
C/ PLACA 4X2**

CÓD. DESCRIÇÃO EMBAL.
8698 6A C/25



**INTERRUPTOR
1 TECLA SIMPLES
C/ PLACA**

CÓD. DESCRIÇÃO EMBAL.
7041 6A C/25



**INTERRUPTOR 1 TECLA
BIPOLAR**

CÓD. DESCRIÇÃO EMBAL.
7052 25A C/10



**INTERRUPTOR
2 TECLA SIMPLES
+ TOMADA FIXA EMB.
BIPOLAR 250V C/ PLACA**

CÓD. DESCRIÇÃO EMBAL.
8697 6/20A C/20



**INTERRUPTOR 2 TECLA
+ TOMADA 2P+T**

CÓD. DESCRIÇÃO EMBAL.
7050 10A C/20
7051 20A C/20



**INTERRUPTOR
SIMPLES C/ PLACA
4X2**

CÓD. DESCRIÇÃO EMBAL.
7044 2 TECLAS C/25



LINHA: STYLUS

**INTERRUPTOR 1 TECLA
SIMPLES + TOMADA
2P+T**

CÓD. DESCRIÇÃO EMBAL.

7047 10A C/20

7048 20A C/20



**TOMADA DUPLA FIXA
EMB. BIPOAR 2P+T**

CÓD. DESCRIÇÃO EMBAL.

8696 10A C/20

7040 20A C/20



**TOMADA FIXA EMB.
BIPOLAR 2P+T 250V**

CÓD. DESCRIÇÃO EMBAL.

9548 10A C/25



**TOMADA TRIPLA
250V**

CÓD. DESCRIÇÃO EMBAL.

7791 10A C/10

8183 20A C/10



**PLACA CEGA
4X2**

CÓD. DESCRIÇÃO EMBAL.

8699 ---- C/20



PLACA CEGA

CÓD. DESCRIÇÃO EMBAL.

7059 4X4 C/20



FILTRO DE LINHA ECONOMICO 5 TOMADAS BIVOLT

CÓD.	DESCRIÇÃO	EMBAL.
9870	BRANCO	C/10
9871	PRETO	C/10



CX. DE DISJ. CDT COMPACTA UNIPOLAR + TOM. 20A 250V

CÓD.	DESCRIÇÃO	EMBAL.
9873	1,00 mt S/DISJ-SOB	C/15



INTERRUPTOR SIMPLES

CÓD.	DESCRIÇÃO	EMBAL.
7046	3 TECLAS	C/10



CX. DE SOBREPOR BRANCO

CÓD.	DESCRIÇÃO	EMBAL.
9872	4X2	C/10



PULSADOR P/ CAMPAINHA

CÓD.	DESCRIÇÃO	EMBAL.
7035	----	C/10



TOMADA TRIPLA 250V

CÓD.	DESCRIÇÃO	EMBAL.
8183	20A	C/10



TOMADA FIXA EMBUTIR BIPOLAR 2P+T 250V

CÓD.	DESCRIÇÃO	EMBAL.
7036	10A	C/25
7037	20A	C/25



**INTERRUPTOR
PARALELO C/ PLACA**

CÓD. DESCRIÇÃO EMBAL.
7045 2 TECLAS C/10



**CONECTOR DE ANTENA
STYLUS C/ PLACA**

CÓD. DESCRIÇÃO EMBAL.
7056 1,00 mt C/20



**TOMADA DE REDE
Rj45**

CÓD. DESCRIÇÃO EMBAL.
7053 8 FIOS C/10



**TOMADA TELEBRAS +
Rj11 C/ PLACA**

CÓD. DESCRIÇÃO EMBAL.
7055 MODULAR C/25



**CIGARRA DE EMBUTIR
BIVOLT**

CÓD. DESCRIÇÃO EMBAL.
7057 ---- C/10



LINHA: BOX

**INTERRUPTOR 1 TECLA
+ TOMADA 2P+T**

CÓD.	DESCRIÇÃO	EMBAL.
7068	10A	C/20
7069	20A	C/20



**INTERRUPTOR 1 TECLA
BIPOLAR 250V**

CÓD.	DESCRIÇÃO	EMBAL.
7070	25A	C/10



**INTERRUPTOR 2 TECLA
SIMPLES SOBREPOR
250V**

CÓD.	DESCRIÇÃO	EMBAL.
8704	6A	C/10



**INTERRUPTOR
SIMPLES 250V**

CÓD.	DESCRIÇÃO	EMBAL.
7793	3 TECLAS	C/20



**INTERRUPTOR
SIMPLES**

CÓD.	DESCRIÇÃO	EMBAL.
7063	1 TECLA	C/20



INTERRUPTOR

CÓD.	DESCRIÇÃO	EMBAL.
7067	20A	C/10



LINHA: BOX

**TOMADA DUPLA FIXA
SOBREPOR BIP. 2P+T
250V**

CÓD.	DESCRIÇÃO	EMBAL.
8701	10A	C/10



**TOMADA FIXA BIPOLAR
SOBREPOR 2P+T 250V**

CÓD.	DESCRIÇÃO	EMBAL.
8702	10A	C/20
8703	20A	C/20



**TOMADA TELEBRAS
+ Rj11**

CÓD.	DESCRIÇÃO	EMBAL.
7073	MODULAR	C/20



**TOMADA DE REDE
1 Rj45**

CÓD.	DESCRIÇÃO	EMBAL.
7072	BRANCO	C/10



LINHA: PRATIKA

**INTERRUPTOR 1 TECLA
SIMPLES 250V**

CÓD.	DESCRIÇÃO	EMBAL.
9100	6A	C/25



**INTERRUPTOR 2 TECLAS
SIMPLES 250V**

CÓD.	DESCRIÇÃO	EMBAL.
9101	6A	C/25



**INTERRUPTOR 3 TECLAS
SIMPLES 250V**

CÓD. DESCRIÇÃO EMBAL.
9102 6A C/10



**INTERRUPTOR 1 TECLA
SIMPLES + TOMADA FIXA
EMB. BIP. 2P+T 250V**

CÓD. DESCRIÇÃO EMBAL.
9103 6/10A C/20



**INTERRUPTOR 2 TECLA
SIMPLES + TOMADA FIXA
EMB. BIP. 2P+T 250V**

CÓD. DESCRIÇÃO EMBAL.
9104 6/10A C/20



**TOMADA FIXA EMB.
BIPOLAR 2P+T 250V**

CÓD. DESCRIÇÃO EMBAL.
9098 10A C/25
9099 20A C/25



**TOMADA DUPLA FIXA
EMB. BIPOLAR 2P+T
250V**

CÓD. DESCRIÇÃO EMBAL.
9096 10A C/20
9097 20A C/20



**PLACA P/ INTERRUPTOR
2 TECLA**

CÓD. DESCRIÇÃO EMBAL.
9105 4X2 C/20



**PLACA CEGA
BRANCO**

CÓD. DESCRIÇÃO EMBAL.
14353 4X2 C/10



**INTERRUPTOR 1 TECLA
SIMPLES VERTICAL**

CÓD. DESCRIÇÃO EMBAL.
7030 10A C/20



**INTERRUPTOR 1 TECLA
SIMPLES + TOMADA**

CÓD. DESCRIÇÃO EMBAL.
7081 10A C/15



**TOMADA DUPLA
MONOBLOCO**

CÓD. DESCRIÇÃO EMBAL.
8705 10A C/15



**TOMADA SIMPLES
HORIZONTAL**

CÓD. DESCRIÇÃO EMBAL.
7086 10A C/20
7087 20A C/20



**TOMADA P/ TV
HORIZONTAL**

CÓD. DESCRIÇÃO EMBAL.
8706 ---- C/10



**INTERRUPTOR 1 TECLA
PARALELA 250V VERT.**

CÓD. DESCRIÇÃO EMBAL.
7042 10A C/20



**INTERRUPTOR 1 TECLA
SIMPLES + TOMADA**

CÓD. DESCRIÇÃO EMBAL.
7085 20A C/20



**INTERRUPTOR 2 TECLA
SIMPLES + TOMADA**

CÓD. DESCRIÇÃO EMBAL.
7082 10A C/20
7083 20A C/20



**INTERRUPTOR 1 TECLA
SIMPLES VERT.**

CÓD. DESCRIÇÃO EMBAL.
7054 25A C/10



**INTERRUPTOR 2 TECLA
SIMPLES**

CÓD. DESCRIÇÃO EMBAL.
7049 10A C/10



**INTERRUPTOR 2 TECLA
PARALELA C/ PLACA**

CÓD. DESCRIÇÃO EMBAL.
7060 10A C/10



**INTERRUPTOR 3 TECLA
SIMPLES**

CÓD. DESCRIÇÃO EMBAL.
7071 10A C/10



**PULSADOR CAMPAINHA
VERTICAL**

CÓD. DESCRIÇÃO EMBAL.
7027 10A C/10



**TOMADA SIMPLES
2 TECLA**

CÓD. DESCRIÇÃO EMBAL.
7084 10A C/15
7038 20A C/15



**TOMADA TRIPLA
SIMPLES**

CÓD. DESCRIÇÃO EMBAL.
7066 10A C/10
7078 20A C/10



**TOMADA TELEBRAS
+ Rj11**

CÓD. DESCRIÇÃO EMBAL.
7031 2 FIOS C/10



LINHA: SLIM

**TOMADA TELEFONE 1
+ Rj11 HORIZONTAL**

CÓD. DESCRIÇÃO EMBAL.
7032 ---- C/10



PLACA CEGA

CÓD. DESCRIÇÃO EMBAL.
8834 4X4 C/20



**PLACA CEGA C/
SUPORTE**

CÓD. DESCRIÇÃO EMBAL.
8707 4X2 C/20



**PLACA CEGA 1
MODULO
HORIZONTAL C/
SUPORTE**

CÓD. DESCRIÇÃO EMBAL.
14354 4X2 C/10



LINHA: LEV

**INTERRUPTOR
SIMPLES 250V**

CÓD. DESCRIÇÃO EMBAL.
9882 10A C/20



**INTERRUPTOR
PARALELO 250V**

CÓD. DESCRIÇÃO EMBAL.
9889 10A C/20



**INTERRUPTOR
2T SIMPLES 250V**

CÓD. DESCRIÇÃO EMBAL.
9883 10A C/20



**INTERRUPTOR
3T SIMPLES 250V**



CÓD.	DESCRIÇÃO	EMBAL.
9884	10A	C/10

TOMADA 250V



CÓD.	DESCRIÇÃO	EMBAL.
9880	10A	C/20
9881	20A	C/20

**TOMADA DUPLA
250V MONOBLOCO**



CÓD.	DESCRIÇÃO	EMBAL.
9876	10A	C/15
9877	20A	C/15

**TOMADA TRIPLA
250V MONOBLOCO**



CÓD.	DESCRIÇÃO	EMBAL.
9878	10A	C/10
9879	20A	C/10

**INTERRUPTOR
SIMPLES 10A + 1 TOMADA**



CÓD.	DESCRIÇÃO	EMBAL.
9885	10A	C/15
9886	20A	C/15

**INTERRUPTOR
SIMPLES + 2 TOMADAS**



CÓD.	DESCRIÇÃO	EMBAL.
9887	10A	C/10

**INTERRUPTOR 2T
SIMPLES + 1 TOMADA**



CÓD.	DESCRIÇÃO	EMBAL.
9888	10A	C/20

**PINO BIP. 3 SAIDAS
TIPO (T) 2P+T BRANCO**

CÓD.DESCRICÃO EMBAL.
10079 10 A C/ 10



**PINO PRENSA CABO
EXTRA GIG. 2P+T CZ
14171PCT**

CÓD.DESCRICÃO EMBAL.
10080 20 A C/ 10



**PINO PRENSA CABO
2P BRANCO 250V**

CÓD.DESCRICÃO EMBAL.
10081 20 A C/10



**PINO FÊMEA BIP.
2P+T BRANCO 250V**

CÓD.DESCRICÃO EMBAL.
10082 10 A C/10
10087 20 A C/10



**PINO PRENSA CABO
2P+T BRANCO 250V**

CÓD.DESCRICÃO EMBAL.
10083 10 A C/ 10
10084 20 A C/ 10



**PINO PRENSA CABO
GIG. 2P+T BRANCO**

CÓD.DESCRICÃO EMBAL.
10085 10 A C/ 10
10086 20A (BRANCO) C/ 10
14374 20A (CINZA) C/ 10



**TOMADA EM BARRA
TRIPLA 10A BR 250V**

CÓD.DESCRICÃO EMBAL.
10096 2P+T C/ 10
10097 2P C/ 10



2P+T

2P

**TOMADA EM BARRA
QUADRUPLA 10A
BR 250V**

CÓD.DESCRICÃO EMBAL.
10098 2P+T C/ 10



**SOQUETE FIXO
250V 150W**

CÓD.	DESCRIÇÃO	EMBAL.
10089	PRETO	C/ 25
10090	BRANCO	C/ 25



**SOQUETE FIXO S/
CHAVE C/ BORNE
250V**

CÓD.	DESCRIÇÃO	EMBAL.
10088	2A	C/ 10



**SOQUETE POP
C/ RABICHO 2A**

CÓD.	DESCRIÇÃO	EMBAL.
10091	PRETO	C/ 10



**SOQUETE 250V
C/ RABICHO 2A**

CÓD.	DESCRIÇÃO	EMBAL.
10092	PRETO	C/ 10
10093	BRANCO	C/ 10



**SOQUETE C/ RABICHO
PRETO ECONOMICO
250V**

CÓD.	DESCRIÇÃO	EMBAL.
14352	2A	C/ 10



**QUADRO DIST.
NEMA/DIN C/ LENTE
EMBUTIR BR**

CÓD.	DESCRIÇÃO	EMBAL.
10100	3/4 DISJ.	C/ 08



**QUADRO DIST.
NEMA/DIN C/ LENTE
EMBUTIR BR**

CÓD.	DESCRIÇÃO	EMBAL.
10101	6/8 DISJ.	C/ 10



**CAIXA DE DISJ. P/
AR CONDICIONANDO
25A + TOM. 20A**

CÓD.	DESCRIÇÃO	EMBAL.
10099	EMBUTIR	----



**QUADRO DIST.
NEMA/DIN C/ LENTE
EMBUTIR BR**

CÓD.	DESCRIÇÃO	EMBAL.
10102	12/16 DISJ.	C/ 04



PLACA CEGA

CÓD. DESCRIÇÃO EMBAL.
9875 4X2 C/20



PLACA CEGA

CÓD. DESCRIÇÃO EMBAL.
9890 4X4 C/20



LINHA: EVIDENCE

**INTERRUPTOR
SIMPLES 1 TECLA**

CÓD. DESCRIÇÃO EMBAL.
11726 16A C/ 50UN



**INTERRUPTOR 2
TECLAS SIMPLES
DIST.**

CÓD. DESCRIÇÃO EMBAL.
11723 16A C/ 10



**INTERRUPTOR 3
TECLAS SIMPLES**

CÓD. DESCRIÇÃO EMBAL.
11725 16A C/ 10



**INTERRUPTOR
PARALELO 1 TECLA**

CÓD. DESCRIÇÃO EMBAL.
11720 16A C/ 10UN



**INTERRUPTOR 2
TECLAS PARALELOS
DIST.**

CÓD.	DESCRIÇÃO	EMBAL.
11724	16A	C/ 10



**INTERRUPTOR
SIMPLES 1 TEC+
TOMADA PADRÃO
2P+T**

CÓD.	DESCRIÇÃO	EMBAL.
11712	10A	C/ 10UN
11730	20A	C/ 10UN



**INTERRUPTOR 2
TECLAS SIMPLES
+ TOMADA PADRÃO
2P+T**

CÓD.	DESCRIÇÃO	EMBAL.
11732	10A	----



**INTERRUPTOR
SIMPLES 1 TEC+
2 TOMADA PADRÃO
2P+T**

CÓD.	DESCRIÇÃO	EMBAL.
11733	10A	C/ 10UN



**INTERRUPTOR
PARALELO + TOM.
PADRÃO 2P+T**

CÓD.	DESCRIÇÃO	EMBAL.
11731	10A	C/ 10



**INTERRUPTOR
PULSADOR CAMP.
C/ PLACA**

CÓD.	DESCRIÇÃO	EMBAL.
11721	16A	C/ 10UN



**INTERRUPTOR BIP.
1 TECLA SIMPLES
C/ PACA**

CÓD.	DESCRIÇÃO	EMBAL.
11722	20A	C/ 10



**TOMADA PADRÃO
DUPLA 2P+T DIST.
C/ PLACA**

CÓD.	DESCRIÇÃO	EMBAL.
11729	10A	C/ 40UN
11727	20A	C/ 10UN



**TOMADA PADRÃO
TRIPLA 2P+T C/
PLACA**

CÓD.	DESCRIÇÃO	EMBAL.
11710	10A	C/ 10UN
15161	20A	C/ 10UN



**PLACA 4X2 C/
SUPORTE DIST.**

CÓD.	DESCRIÇÃO	EMBAL.
14788	P/ 1 MODULOS	C/ 20UN



**PLACA 4X2 C/
SUPORTE DIST.**

CÓD.	DESCRIÇÃO	EMBAL.
11737	P/ 3 MODULOS	C/ 20UN



**PLACA 4X2 C/
SUPORTE DIST.**

CÓD.	DESCRIÇÃO	EMBAL.
14789	P/ 2 MODULOS	C/ 20UN

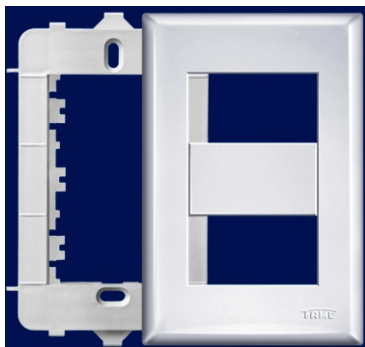

**PLACA CEGA 4X2
C/ SUPORTE**

CÓD.	DESCRIÇÃO	EMBAL.
11734	----	C/ 20UN

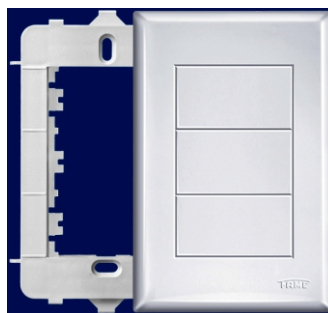

**INTERRUPTOR
MODULO PARALELO
SM/EV BLANC+**

CÓD.	DESCRIÇÃO	EMBAL.
14302	16 A	C/ 20UN



**PLACA CEGA
BLANC+**

CÓD.	DESCRIÇÃO	EMBAL.
14303	4X2	C/ 20UN





**DUCHA BLINDADA
ELETRICA 220V**

CÓD. DESCRIÇÃO EMBAL.
11713 3500W C/ 02



**SUPER DUCHA 4T
220V C/ CANO 30CM**

CÓD. DESCRIÇÃO EMBAL.
14307 3200W ----



**DUCHA FAMINHO
4T 220V C/ CANO
30CM**

CÓD. DESCRIÇÃO EMBAL.
14777 6800W CX C/ 10



**DUCHA GRAN DUCHA
JATO FORTE 220V**

CÓD. DESCRIÇÃO EMBAL.
14776 7000W CX C/02



**RESISTENCIA 220V
P/ DUCHA FAMINHO**

CÓD. DESCRIÇÃO EMBAL.
14778 6800W C/ 05



**PLUGUE PADRAO
JUNÇÃO MACHO
2P +T PRETO**

CÓD. DESCRIÇÃO EMBAL.
14783 10A C/ 50



**PLUGUE PADRAO
JUNÇÃO MACHO
2P PRETO**

CÓD. DESCRIÇÃO EMBAL.
14782 10A C/ 50



**PLUGUE PADRAO
JUNÇÃO MACHO
2P + T CINZA**

CÓD. DESCRIÇÃO EMBAL.
14781 20A C/ 25



R. São José, 508 - Centro - Areial-PB
(83) 3368-1121
ajalesatmc@hotmail.com

**TOMADA PADRÃO
JUNÇÃO FEMEA
2P PRETO**

CÓD. DESCRIÇÃO EMBAL.
14784 10A C/ 50



**TOMADA PADRÃO
JUNÇÃO FEMEA
2P+T PRETO**

CÓD. DESCRIÇÃO EMBAL.
14785 10A C/ 50



**PLUGUE PADRÃO
SAIDA LATERAL
2P+T CINZA**

CÓD. DESCRIÇÃO EMBAL.
14786 20A POTE C/22



**TOMADA PADRÃO
JUNÇÃO FEMEA
2P CINZA**

CÓD. DESCRIÇÃO EMBAL.
14780 10A C/ 50



**PLUGUE (TIPO T)
3 TOMADAS 2P+T**

CÓD. DESCRIÇÃO EMBAL.
14787 10A C/ 35



**TOMADA P/ ANTENA
DE TV**

CÓD. DESCRIÇÃO EMBAL.
14779 CABO COAXIAL C/ 10



LINHA: SOBREPOR

**INTERRUPTOR
MODULO SIMPLES**

CÓD. DESCRIÇÃO EMBAL.
11719 16A C/ 20



**PLUGUE PADRÃO
250V 2P CINZA**

CÓD. DESCRIÇÃO EMBAL.
11715 10A C/ 50UN





**PLUGUE PADRÃO
250V 2P+T CINZA**

CÓD. DESCRIÇÃO EMBAL.
11718 10A C/ 50UN



**TOMADA MÓDULO
PADRÃO 2P+T**

CÓD. DESCRIÇÃO EMBAL.
11714 10A C/ 20UN
15162 20A C/ 10UN



**PLUGUE PADRÃO
250V PRENSA CABO
2P+T CINZA**

CÓD. DESCRIÇÃO EMBAL.
11716 20A C/ 25UN



**TOMADA PADRÃO
FEMEA 2P+T 250V**

CÓD. DESCRIÇÃO EMBAL.
11717 10A C/ 50UN



**QUADRO DISJ.
NEMA BRANCO**

CÓD. DESCRIÇÃO EMBAL.
15216 12/16 DIN C/ 02UN

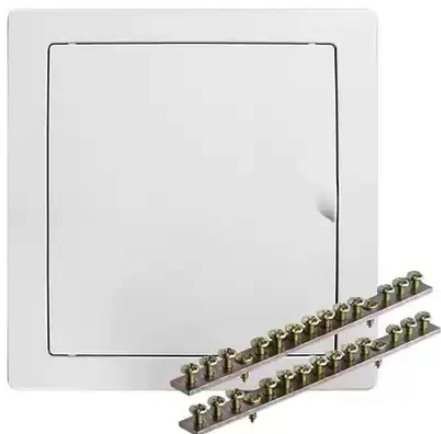

**QUADRO DISJ.
NEMA BRANCO**

CÓD. DESCRIÇÃO EMBAL.
15217 6/8 DIN C/ 04UN



**CAIXA DER LUZ
AMARELO**

CÓD. DESCRIÇÃO EMBAL.
14285 4X2 C/ 24



**CAIXA P/ LAJE
LARANJA**

CÓD. DESCRIÇÃO EMBAL.
14284 CX. DE CENTRO C/ 10

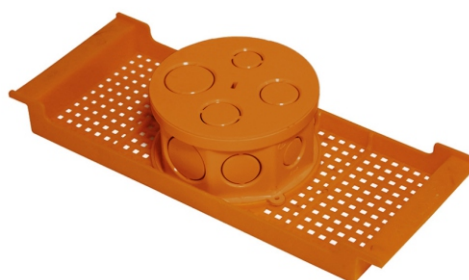

R. São José, 508 - Centro - Areial-PB
(83) 3368-1121
ajalesatmc@hotmail.com

**CORRUGADO PVC
ELETRODUTO FLEX**

CÓD.	DESCRIÇÃO	EMBAL.
15014	20MM	RL C/50MT
14281	25MM	RL C/50MT

**TUBO ELETRODUTO
ROSC. ANTI CHAMADA**

CÓD.	DESCRIÇÃO	EMBAL.
4055	3/4"	C/ 10

**CURVA 90° CURTO
ROSCAVEL P/ ELET.**

CÓD.	DESCRIÇÃO	EMBAL.
CURTO		
14275	3/4"	C/ 24
14276	1"	C/ 12
LONGO		
14277	3/4"	C/ 24
14278	1"	C/ 12



CURTO



LONGO

**LUVA P/ ELETRODUTO
ROSCAVEL**

CÓD.	DESCRIÇÃO	EMBAL.
14279	3/4"	C/ 30
14280	1"	C/ 50

**LUVA PRESSAO AM.
P/ CORRUGADO**

CÓD.	DESCRIÇÃO	EMBAL.
14282	25MM	C/ 50
14283	32MM	C/ 30

**CORRUGADO
ELETRODUTO AM.**

CÓD.	DESCRIÇÃO	EMBAL.
8598	20MM - 1/2"	C/50MT
7515	25MM - 3/4"	C/50MT

**TUBO ELETRODUTO
PVC RIGIDO ROSC.
3MT**

CÓD.	DESCRIÇÃO	EMBAL.
12023	3/4"	C/ 10UN
15130	1"	C/ 10UN

**TUBO ELETRODUTO
RIGIDO C/ BOLSA 3MT**

CÓD.	DESCRIÇÃO	EMBAL.
15129	20MM	C/ 10UN





CHAVE TESTE DIGITAL

CÓD.	DESCRIÇÃO	EMBAL.
11787	12-220V	C/24UN



TESTE VOLTAGEM 8 EM 1

CÓD.	DESCRIÇÃO	EMBAL.
10724	6V A 380V	----



PILHA ALCALINA AAA E AA 1,5V CT C/02

CÓD.	DESCRIÇÃO	EMBAL.
10499	PALITO	CX C/30
10500	PEQUENO	CX C/20



MULTÍMETRO DIGITAL

CÓD.	DESCRIÇÃO	EMBAL.
10759	DT-830	----



PILHA ALCALINA BATERIA

CÓD.	DESCRIÇÃO	EMBAL.
10503	9 V	CX C/30



MULTÍMETRO DIGITAL

CÓD.	DESCRIÇÃO	EMBAL.
11786	DISPLAY 2,5"	----



PILHA BATERIA LITIO 3V CT C/5

CÓD.	DESCRIÇÃO	EMBAL.
10695	CR 2016	C/10 CT
10696	CR 2025	C/10 CT
10697	CR 2032	C/10 CT



PILHA ALCALINA BATERIA

CÓD.	DESCRIÇÃO	EMBAL.
10504	12 V	CX C/12



PILHA ALCALINA AAA 1,5V CT C/02

CÓD.	DESCRIÇÃO	EMBAL.
10501	MÉDIA	CX C/12
10502	GRANDE	CX C/12



R. São José, 508 - Centro - Areal-PB
(83) 3368-1121
ajalesatmc@hotmail.com

**LÂMPADA MISTA
160W 220V LATÃO**

CÓD.	DESCRIÇÃO	EMBAL.
7625	E-27	C/20UN



**LÂMPADA MAQ.
COST ENCAIXE
15W 220V**

CÓD.	DESCRIÇÃO	EMBAL.
10910	MAQ. COSTURA	C/50UN
8911	GEL./ MICRO.	C/50UN

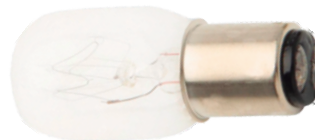

**TIMER DIGITAL
60HZ**

CÓD.	DESCRIÇÃO	EMBAL.
10767	BIVOLT	----



**SOQUETE P/ LAMP.
DICROICA**

CÓD.	DESCRIÇÃO	EMBAL.
10693	C/ RABICHO	C/ 20



**ABAJUR LUZ NOT.
LED BARCO 220V**

CÓD.	DESCRIÇÃO	EMBAL.
6903	AZUL	C/24UN



**ABAJUR LUZ NOT.
LED CONCHA 220V**

CÓD.	DESCRIÇÃO	EMBAL.
6905	BRANCO	C/24UN



**ABAJUR LUZ NOT.
LED 220V**

CÓD.	DESCRIÇÃO	EMBAL.
6904	CASA	C/24UN
6907	LUA	C/24UN



**ABAJUR LUZ NOT.
LED BORBOLETA 220V**

CÓD.	DESCRIÇÃO	EMBAL.
7757	ROSA	C/24UN





BOCAL PORCELANA P/ SPOPT ALÇA

CÓD.	DESCRIÇÃO	EMBAL.
6927	E-27	C/25UN



LÂMPADA MAQ. COST ROSC. 15W 220V

CÓD.	DESCRIÇÃO	EMBAL.
7754	E-27	C/50



REFLETOR SLIM LED BIVOLT

CÓD.	DESCRIÇÃO	EMBAL.
10341	30W	----
10342	50W	----
10474	100W	----



PAINEL POP SOBREPOR QUAD. LED BIV.

CÓD.	DESCRIÇÃO	EMBAL.
10425	17CM 12W	----
10343	22CM 18W	----
10424	30CM 24W	----



PAINEL POP EMBUTIR QUAD. LED

CÓD.	DESCRIÇÃO	EMBAL.
10344	17CM 12W	----
10345	22CM 18W	----
10346	30CM 24W	----



SPOT SUPIMPA QUAD. LED BIV.

CÓD.	DESCRIÇÃO	EMBAL.
10347	LUZ BRANCA 5W	----
10348	3W	----
14632	LUZ AMARELO 5W	----



LAMP. SUPERLED PÊRA

CÓD.	DESCRIÇÃO	EMBAL.
12053	7W	C/10
11500	9W	C/10
11669/ 12444	12W	C/10
14629	15W	C/10



LAMP. BULBO A55 HALOGENO 220V

CÓD.	DESCRIÇÃO	EMBAL.
10417	42W	C/10
10418	70W	C/10



R. São José, 508 - Centro - Areial-PB
(83) 3368-1121
ajalesatmc@hotmail.com

LAMP. BULBO HP IN E27



CÓD.	DESCRIÇÃO	EMBAL.
10423	20W	C/10
11670	30W	----
14630	40W	----
11598	50W	----

LAMP. SUPERLED BOLINHA NI E27 4W



CÓD.	DESCRIÇÃO	EMBAL.
11387	VERDE	----
11388	VERMELHO	----
14620	AZUL	----
14626	AMARELO	----



LAMP. TUBULAR LED T8 IN VIDRO BIVOLT



CÓD.	DESCRIÇÃO	EMBAL.
11392/ 11599	9W	C/ 25
12445/ 11597	18W	C/ 25



LUMINARIA SUPER LED ELEGANCE BIVOLT



CÓD.	DESCRIÇÃO	EMBAL.
11394	18W	----
11395	36W	----

LUMINARIA LED ARANDELA BIV. HUMMER



CÓD.	DESCRIÇÃO	EMBAL.
14617	5W	----
14616	12W	----

ESPETO LED P/ JARDIM HUMMER



CÓD.	DESCRIÇÃO	EMBAL.
14618	LUZ BR-5W	----
19	LUZ AM-12W	----

LAMPADA RETRO PERA VINTAGE LED



CÓD.	DESCRIÇÃO	EMBAL.
14621	2W	C/ 10UN

FITA LED INTERNA 4,8W/M TRANSF 12V



CÓD.	DESCRIÇÃO	EMBAL.
14625	LUZ AMARELA	RL/5MT
14745	LUZ BRANCA	RL/5MT

ARANDELA DUE ELEGANCE 3W

MODELO



DIMENSÕES

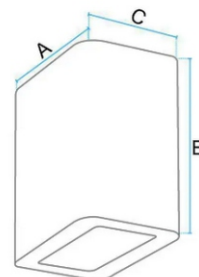

CÓD.	DESCRIÇÃO	EMBAL.
14622	BRANCO	----
14623	PRETO	----
14624	CAFÉ	----

LUSTRE LUMINARIA PENDENTE PRIMUS P/ 3 LAMPADAS

CÓD.	DESCRIÇÃO	EMBAL.
14628	PRETO FOSCO	----



Dimensões: A: 120mm x B: 120mm x C:50mm

LUSTRE LUMINARIA PENDENTE PRIMUS P/ 1 LAMPADA

CÓD.	DESCRIÇÃO	EMBAL.
14627	PRETO FOSCO	----



PAINEL POP EMBUTIR REDONDO BIV. 17CM

CÓD.	DESCRIÇÃO	EMBAL.
14631	12W	----



AVANT

SEU MELHOR PARCEIRO EM ILUMINAÇÃO

LUZ NORTUNA 1W BIVOLT

CÓD.	DESCRIÇÃO	EMBAL.
11428	MONSTRINHO	----
11429	ELEFANTE	----
11430	PIGUIN	----
11431	BULLDOG	----
14610	BOLA	----
14611	ASTRO	----
14612	ANGELO	----
14613	SERENA	----
14614	BESOURO	----
14615	CORUJINHA	----



EXATRON

Produtos Inteligentes

**RELÉ FORTELÉTRICO
RETARDO 220V SLIM**

CÓD.DESCRICÃO EMBAL.
4805 - ----



**BASE GIRATÓRIA
FIXA P/ RELÉ**

CÓD. DESCRICÃO EMBAL.
10989 TIPO "L" ----



LORENZETTI

Mais do que você imagina

**RESISTÊNCIA 3T
220V CHUVEIRO
LOREN ULTRA**

CÓD.DESCRICÃO EMBAL.
9709 065B 4600W C/12UN
9710 065R 3200W C/12UN



**RESISTÊNCIA
220V MD/J3 P/
CHUVEIRO**

CÓD. DESCRICÃO EMBAL.
6977 3200W 055R C/25UN
6978 4600W 055-B C/25UN



LEDVANCE

**LAMPADA LED
CLA60 6500J BIV.
E27**

CÓD. DESCRICÃO EMBAL.
14314 8W C/10 UN



**CORRUGADO
AMARELO**

CÓD. BITOLA EMBAL.
9381/10921 3/4" ----
9382 5/8" ----



Ajales
DISTRIBUIDOR
MATERIAL DE CONSTRUÇÃO

R. São José, 508 - Centro - Areial-PB
(83) 3368-1121
ajalesatmc@hotmail.com



**CONECTOR CUNHA
COBRE CDCR**

CÓD.	DESCRIÇÃO	EMBAL.
10261	III - VM	----
10262	II - VD	----



**CONECTOR DERIVACAO
PERFURACAO**

CÓD.	DESCRIÇÃO	EMBAL.
10263	CDP-70	----
10272	CDP-120	----
11875	CDP-150	----



SHIN TECH

**SPOT ALETADO
BRANCO 220V**

CÓD.	DESCRIÇÃO	EMBAL.
9974	SIMPLES	----
9975	DUPLO	----



**SPOT ALETADO
PRETO 220V**

CÓD.	DESCRIÇÃO	EMBAL.
9976	SIMPLES	----
9977	DUPLO	----



**LUM. TARTARUGA
MOD.2 PLASTICO
110/220V**

CÓD.	DESCRIÇÃO	EMBAL.
11609	BRANCO	----
11610	PRETO	----



R. São José, 508 - Centro - Areial-PB
(83) 3368-1121
ajalesatmc@hotmail.com



**LUMINARIA
TARTARUGA
S/ GRADE 1xE27**

CÓD.	DESCRIÇÃO	EMBAL.
12062	BRANCO	----



**LUMINARIA
TARTARUGA
C/ GRADE 1xE27**

CÓD.	DESCRIÇÃO	EMBAL.
12060	BRANCO	----
12061	PRETO	----



**PLAFON C/ SOQ.
DE PORCELANA**

CÓD.	DESCRIÇÃO	EMBAL.
11956	E-27	----



**TUBO ELETRODUTO
GALVANIZADO
3,00 MT**

CÓD.	BITOLA	EMBAL.
6205	3/4" - DN 20	C/01UN
6204	1" - DN 25	C/01UN



**CURVA ELETRODUTO
ROSCADA GALV. 0,50**

CÓD.	BITOLA	EMBAL.
11650	3/4" - DN 20	----
11651	1" - DN 25	----



**EMBULIDOR
ALUMINIO**

CÓD.	DESCRIÇÃO	EMBAL.
10205	1000W/220V	----



R. São José, 508 - Centro - Areial-PB
(83) 3368-1121
ajalesatmc@hotmail.com

ARANDELA SOQ. E-27 SUPORTE AÇO COLONIAL

CÓD.	DESCRIÇÃO	EMBAL.
12968	BRANCO	----
12963	INOX	----



ARANDELA SOQ. E-27 SUPORTE AÇO COLONIAL

CÓD.	DESCRIÇÃO	EMBAL.
12969	PRETO	----



Roma

Pincéis & Acessórios

CAIXA DE LUZ AM.

CÓD.	TAM.	EMBAL.
9070	4X2	C/24



CAIXA DE LUZ C/ SUPORTE 300mm

CÓD.	DESCRIÇÃO	EMBAL.
9071	OCTAGONAL	C/12



SOPRANO

Faz melhor para você.

DISJ. BRANCO MONOFASICO SHB1 GII

CÓD.	DESCRIÇÃO	EMBAL.
8769	CO10A	----
8771	CO16A	----
8773	CO20A	----
8775	CO25A	----
8777	CO32A	----
8779	CO40A	----
8781	CO50A	----



DISJ. BRANCO TRIFASICO SHB3 GII

CÓD.	DESCRIÇÃO	EMBAL.
8770	CO10A	----
8772	CO16A	----
8774	CO20A	----
8776	CO25A	----
8778	CO32A	----
8780	CO40A	----
8782	CO50A	----
8783	CO63A	----



CHAVE BOIA CBS-1,2M

CÓD.	DESCRIÇÃO	EMBAL.
8546	-	----



DISJ. BRANCO DIFERENCIAL

CÓD.	DESCRIÇÃO	EMBAL.
9836	25A	----
9837	40A	----





FITA ISOLANTE P/ ALTA TENSAO AUTOFUSÃO

CÓD.	DESCRIÇÃO	EMBAL.
7888	19mm X 2m	----
7889	19mm X 5m	----



FITA ISOLANTE IMPERIAL

CÓD.	DESCRIÇÃO	EMBAL.
7498	18mm x 05m	PC 10UN
7497	18mm X 10m	PC 10UN
7535	18mm x 20m	PC 10UN



CAIXA DE LUZ AM. EXTRA FORTE

CÓD.	DESCRIÇÃO	EMBAL.
11438	4X2	C/100UN



CAIXA DE LUZ PRETO

CÓD.	DESCRIÇÃO	EMBAL.
11437	4X2	C/100UN



CAIXA DE LUZ AM. EXTRA FORTE

CÓD.	DESCRIÇÃO	EMBAL.
12625	OCTAGONAL	----



CAIXA P/ LAJE EXTRA FORTE REGULAVEL

CÓD.	DESCRIÇÃO	EMBAL.
12616	AMARELO EXT. FORTE	----
12603	PRETO	----



CAIXA P/ LAJE

CÓD.	DESCRIÇÃO	EMBAL.
12351	AMARELO	----
12602	PRETO	----



R. São José, 508 - Centro - Areial-PB
(83) 3368-1121
ajalesatmc@hotmail.com



**FILTRO DE LINHA
CABO 1,20MT**

CÓD. DESCRIÇÃO EMBAL.
14474 3 TOMADAS ----



**FILTRO DE LINHA
CABO 1,20MT**

CÓD. DESCRIÇÃO EMBAL.
14762 4 TOMADAS ----



**FILTRO DE LINHA
CABO 1,20MT**

CÓD. DESCRIÇÃO EMBAL.
14475 5 TOMADAS ----



**FILTRO DE LINHA
CABO 1,20MT**

CÓD. DESCRIÇÃO EMBAL.
14763 6 TOMADAS ----



**FILTRO DE LINHA
CABO 1,20MT**

CÓD. DESCRIÇÃO EMBAL.
14476 8 TOMADAS ----



**FILTRO DE LINHA
CABO 1,20MT**

CÓD. DESCRIÇÃO EMBAL.
14473 10 TOMADAS ----



**CONTROLE P/
VENTILADOR
E LAMPADA**

CÓD. DESCRIÇÃO EMBAL.
14768 VENTILADOR+
1 LAMPADA ----
14769 VENTILADOR+
2 LAMPADA ----

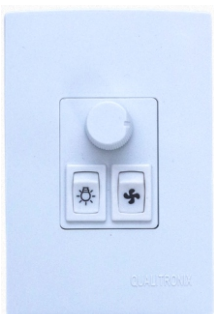

14768



14769

**CAMPAINHA S/ FIO
Qc1**

CÓD. DESCRIÇÃO EMBAL.
14472 BRANCO



R. São José, 508 - Centro - Areial-PB
(83) 3368-1121
ajalesatmc@hotmail.com



**CONTROLE P/
VENTILADOR E
LAMPADA EMBUTIR
Qv36**

CÓD. DESCRIÇÃO EMBAL.
14767 DESLIZANTE ----

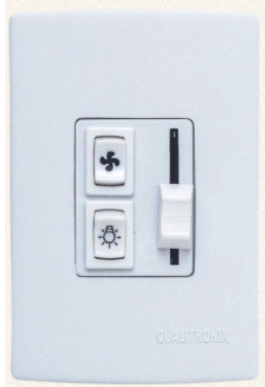

**CONTROLE P/
VENTILADOR
Qv38**

CÓD. DESCRIÇÃO EMBAL.
14770 SOBREPOR ----



**CONTROLE P/
VENTILADOR OU
LUMINOSIDADE
DA LAMPADA Qv36**

CÓD. DESCRIÇÃO EMBAL.
14771 SOBREPOR ----



**RELE FOTOCELULA
Qr54**

CÓD. DESCRIÇÃO EMBAL.
14477 P/ BASE ----



**RELE FOTOCELULA
Qr51**

CÓD. DESCRIÇÃO EMBAL.
14766 CORUJITO ----

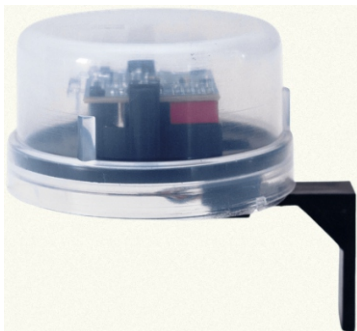

**SENSOR DE
PRESENÇA 360 GRAU
MICROCON. QA19M**

CÓD. DESCRIÇÃO EMBAL.
14471 FOTOCELULA ----



**SENSOR DE
PRESENÇA 180GRAU
MICROCON. QA21M**

CÓD. DESCRIÇÃO EMBAL.
14760 C/ FOTOCELULA ----



**SENSOR DE
PRESENÇA 180GRAU
MICROCON. C/ CHAVE
QI6M**

CÓD. DESCRIÇÃO EMBAL.
14765 C/ FOTOCELULA ----





SENSOR DE PRESENÇA 180GRAU MICROCON. QA26M

CÓD. DESCRIÇÃO EMBAL.
14761 C/ FOTOCELULA ----



SENSOR DE PRESENÇA 180 GRAU MICROCON. S/ CHAVE QI2M

CÓD. DESCRIÇÃO EMBAL.
14764 FOTOCELULA ----

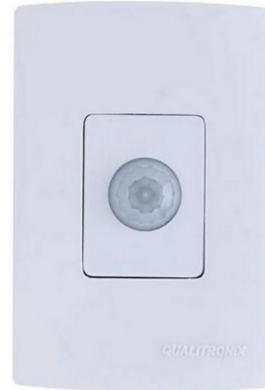

SENSOR DE PRESENÇA 360GRAU MICROCON. QA17M

CÓD. DESCRIÇÃO EMBAL.
14759 C/ FOTOCELULA ----



CONTROLE REMOTO P/ VENTILADO E LAMPADA Qv40

CÓD. DESCRIÇÃO EMBAL.
14772 BRANCO ----



FITA DE LED 12V 14,4W RL C/5MT DE FITA

CÓD. DESCRIÇÃO EMBAL.
14797 3000K ----
14798 6000K ----



600 LÚMENS

5050

FITA DE LED 12V RGB 3,6W RL C/5MT DE FITA

CÓD. DESCRIÇÃO EMBAL.
14794 C/ CONTROLE ----



2835



R. São José, 508 - Centro - Areial-PB
(83) 3368-1121
ajalesatmc@hotmail.com

**FITA DE LED 220V
+ ACESSORIOS 4.8W
RL C/5MT DE FITA**

CÓD. DESCRIÇÃO EMBAL.

14792	3000K	----
14793	6000K	----



200 LÚMENS

2835

**FITA DE LED 12V
4.8W RL C/5MT**

CÓD. DESCRIÇÃO EMBAL.

14795	3000K	----
14796	6000K	----



150 LÚMENS

2835

**SPOT TUBINHO
DUPLO 2 LAMPADAS
C/ ALERTA PRETO**

CÓD. DESCRIÇÃO EMBAL.

14832	BRANCO	----
14833	PRETO	----



**SPOT SIMPLES C/
ALERTA PRETO**

CÓD. DESCRIÇÃO EMBAL.

14830	BRANCO	----
14831	PRETO	----



**PLAFON DECOATIVO
REC. CERAMICO E27
C/TRAVESSA**

CÓD. DESCRIÇÃO EMBAL.

14834	BRANCO	----
-------	--------	------



**LUMINÁRIA TARTARUGA
CHAPA OVAL E27
POLIBUT.**

CÓD. DESCRIÇÃO EMBAL.

8293	BRANCO	----
8294	PRETO	----



**ARANDELA BRAÇO
AO TEMPO**

CÓD. DESCRIÇÃO EMBAL.

8300	30cm	----
------	------	------



PASSA FIO PVC



CÓD.	DESCRIÇÃO	EMBAL.
8297	10cm	----
8298	15cm	----
8299	20cm	----

FITA LISA P/ POSTE



CÓD.	DESCRIÇÃO	EMBAL.
14827	19MM x 30MT	----

TRILHO DIN LISO BARRA 2MT



CÓD.	DESCRIÇÃO	EMBAL.
14829	35X7,5	----

FITA PERFURADA P/ POSTE







CÓD.	DESCRIÇÃO	EMBAL.
14828	19MM x 30MT	----



Fios e Cabos Elétricos

CABO SILFLEX 750V



- AZ 
- BR 
- PR 
- VD 
- VM 

CÓD.	BITOLA	EMBAL.
9723	1,50mm AZ	100MT
9722	1,50mm BR	100MT
9721	1,50mm PR	100MT
9725	1,50mm VD	100MT
9724	1,50mm VM	100MT
9728	2,50mm AZ	100MT
9727	2,50mm BR	100MT
9726	2,50mm PR	100MT
9730	2,50mm VD	100MT
9729	2,50mm VM	100MT
9732	4,00mm AZ	100MT
9731	4,00mm PR	100MT
9733	4,00mm VM	100MT
12982	4,00mm VD	100MT
9735	6,00mm AZ	100MT
9734	6,00mm PR	100MT
9736	6,00mm VM	100MT

CABO SILFLEX PP 500V



CÓD.	BITOLA	EMBAL.
9743	2x1,00 PR	100MT
9744	2x1,50 PR	100MT
9745	2x2,50 PR	100MT
9746	3x1,00 PR	100MT
9747	3x1,50 PR	100MT
9748	3x2,50 PR	100MT

CORDÃO FLEX PARALELO 300V

CÓD.	BITOLA	EMBAL.
9737	0,75mm	100MT
9738	1,00mm	100MT
9739	1,50mm	100MT
9740	2,50mm	100MT

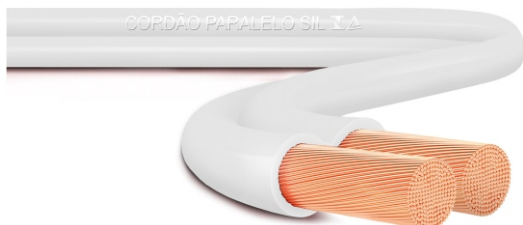

CABO RIGIDO SILNAX 0,6/1 KV HEPR 90C

CÓD.	BITOLA	EMBAL.
9742	6,00mm AZ	100MT
9741	6,00mm PR	100MT



AZ  PR 

FERTAK TOOLS

FERRAMENTAS PROFSSIONAIS

BOCAL PORCELANA E27 BRANCO

CÓD.	DESCRIÇÃO	EMBAL.
14350	TIPO SPOT	PCT C/12



BOCAL PORCELANA C/ ADAPTADOR

CÓD.	DESCRIÇÃO	EMBAL.
14351	E27 P/ E40	C/10



BOCAL C/ RABICHO E27 TERMOPLASTICO PENDENTE 4A 250V

CÓD.	DESCRIÇÃO	EMBAL.
14950	BRANCO	C/50
14951	PRETO	C/50



BOCAL SOQUETE PORCELANA C/ BORNE E27

CÓD.	DESCRIÇÃO	EMBAL.
14948	4A/250V	C/12



BOCAL SOQUETE PORCELANA C/ ALÇA E BORNE E27

CÓD.	DESCRIÇÃO	EMBAL.
14949	4A/250V	C/12



ROLDANA ISOLADOR

CÓD.	DESCRIÇÃO	EMBAL.
14952	72X72MM	C/10



FERTAK TOOLS

FERRAMENTAS PROFSSIONAIS

CONCTOR BIPOLAR PORCELANA 250V

CÓD.	DESCRIÇÃO	EMBAL.
14346	10MM 10A	C/12
14347	16MM 30A	C/12



CONCTOR TRIPOLAR PORCELANA 250V

CÓD.	DESCRIÇÃO	EMBAL.
14348	10MM 10A	C/12
14349	16MM 30A	C/12



CHAVE BOIA ELETRICA DE NIVEL

CÓD.	DESCRIÇÃO	EMBAL.
14915	15A	----
14916	25A	----



CAIXA DE LUZ OCTAGONAL PROLONGAVEL

CÓD.	DESCRIÇÃO	EMBAL.
15092	PRETO	C/36UN



Franmig

KIT SALVA TOMADA C/ PARAFUSO

CÓD.	DESCRIÇÃO	EMBAL.
15202	4X2	----
15203	4X4	----

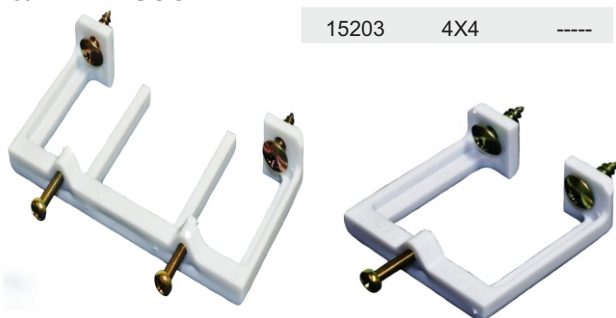

CAIXA DE LUZ OCTAGONAL C/ SUPORTE REGULAVEL

CÓD.	DESCRIÇÃO	EMBAL.
15093	P/ LAJE	C/10UN



R. São José, 508 - Centro - Areial-PB
(83) 3368-1121
ajalesatmc@hotmail.com