



HIDRÁULICO

ALUMASA®

ALUMÍNIO E PLÁSTICO

ASSENTO SANITÁRIO NOVO

CÓD. DESCRIÇÃO EMBAL.

6221 AMARELO TERRA C/10UN

6216 BRANCO C/10UN

6217 CAMELO C/10UN

6218 CINZA CLARO C/10UN

6219 CINZA ESCURO C/10UN



Cinza Claro Cinza Escuro Branco Amarelo Terra Caramelo

CAIXA DE DESCARGA NOVO

CÓD. DESCRIÇÃO EMBAL.

6220 AMARELO TERRA C/10UN

5654 AREIA C/10UN

5650 BRANCO C/10UN

5651 CAMELO C/10UN

5652 CINZA CLARO C/10UN

5653 CINZA ESCURO C/10UN

8229 CRME C/10UN



Branco Cinza Claro Cinza Escuro



Areia Creme Amarelo Terra Caramelo

TORNEIRA BÓIA BALÃO TUBULAR ALUMÍNIO

CÓD. DESCRIÇÃO EMBAL.

7738 1/2 C/10UN



1/2

SPUDE P/ VASO SANITÁRIO

CÓD. DESCRIÇÃO EMBAL.

7744 BRANCO C/20UN



ENGATE FLEXÍVEL 1/2"

CÓD. DESCRIÇÃO EMBAL.

7739 30cm C/10UN

7740 40cm C/10UN

7741 50cm C/10UN

7742 60cm C/10UN



TUBO P/ DESCARGA COM CURVA

CÓD. DESCRIÇÃO EMBAL.

7743 1.20mt C/10UN



R. São José, 508 - Centro - Areal-PB
(83) 3368-1121
ajalesatmc@hotmail.com

CHUVEIRO C/ BRAÇO C/ REG. 30CM 1/2

CÓD.	BITOLA	EMBAL.
4175	5"	C/06UN
5315	7"	C/06UN



CHUVEIRO C/ BRAÇO S/ REG. 30CM

CÓD.	BITOLA	EMBAL.
4171	5" 1/2	C/06UN
5314	7" 1/2	C/06UN
8460	8" 3/4	-----



DUCHA HIGIÊNICA C/ REGISTRO

CÓD.	DESCRIÇÃO	EMBAL.
5320	BRANCA	----
5319	CROMADA	----

5320 - Branca



5319 - Cromada

ENGATE FLEXÍVEL

CÓD.	DESCRIÇÃO	EMBAL.
6833	30cm	C/12UN
6834	40cm	C/12UN
6835	50cm	C/12UN



ESGUICHO PISTOLA C/ ENGATE P/ MANGUEIRA

CÓD.	BITOLA	EMBAL.
7623	1/2"	----



ESGUICHO PISTOLA P/ ENGATE RÁPIDO

CÓD.	BITOLA	EMBAL.
5814	1/2"	C/12UN



GATILHO PISTOLA DUCHA HIGIÊNICA

CÓD.	DESCRIÇÃO	EMBAL.
8125	BRANCO	C/01UN
8126	CROMADO	C/01UN

8125 - Branco



8126 - Cromado



KIT REPARO PRETO

CÓD.	BITOLA	EMBAL.
4408	1/2" e 3/4"	C/12UN



GRELHA + PORTA GRELHA

CÓD.	DESCRIÇÃO	EMBAL.
11618	QUADRADO	C/06UN
11619	REDONDO	C/06UN



REFIL PURIFICADOR (VELA)

CÓD.	DESCRIÇÃO	EMBAL.
6837	P/ FILTRO	----





MARCA DE QUALIDADE

**ARMÁRIO P/
BANHEIRO**



CÓD.	DESCRIÇÃO	EMBAL.
4184	BEGE	C/02UN
4181	BRANCO	C/02UN
4185	CARAMELO	C/02UN
4182	CINZA CLARO	C/02UN
4183	CINZA ESCURO	C/02UN



**PORTA SHAMPOO
P/BANHEIRO**

CÓD.	DESCRIÇÃO	EMBAL.
6841	BEGE	C/01UN
5318	BRANCO	C/01UN
6840	CINZA CLARO	C/01UN



BEGE



BRANCO



CINZA CLARO

**LAVATÓRIO
PLÁSTICO**

CÓD.	DESCRIÇÃO	EMBAL.
4178	BEGE	C/01UN
4176	BRANCO	C/01UN
4180	CARAMELO	C/01UN
4177	CINZA CLARO	C/01UN
4179	CINZA ESCURO	C/01UN



**ASSENTO SANT.
ALMOFADADO**



Preto



**ASSENTO SANT.
ENVOLVENTE**



Ocre



**TANQUE BRANCO
PLASTICO**



CÓD.	DESCRIÇÃO	EMBAL.
10050	20 LT	----

**SUPORE
P/ GARRAFÃO
C/ TORNEIRA**



CÓD.	DESCRIÇÃO	EMBAL.
4719	BRANCO	C/01UN



R. São José, 508 - Centro - Areial-PB
(83) 3368-1121
ajalesatmc@hotmail.com

**REGISTRO DE ESFERA
MARROM
SOLDÁVEL**



CÓD.	BITOLA	EMBAL.
4405	20mm	C/12UN
4406	25mm	C/12UN
4714	32mm	C/12UN
4715	40mm	C/12UN
4717	50mm	C/12UN

**REGISTRO DE ESFERA
MARROM
ROSCA**



CÓD.	BITOLA	EMBAL.
5810	1/2"	C/12UN

**REGISTRO PVC
C/ CANOPLA
BRANCO**



CÓD.	BITOLA	EMBAL.
5812	20mm	C/12UN

**REGISTRO
PRESSÃO C/ ROSCA
C/ CONOPLA**



CÓD.	BITOLA	EMBAL.
5813	1/2"	C/12UN

**REGISTRO PVC
S/ CANOPLA**



CÓD.	BITOLA	EMBAL.
	BRANCO	
4407	20mm	C/12UN
8124	25mm	C/12UN
	MARROM	
4187	20mm	C/12UN
5811	25mm	C/12UN

**REGISTRO P/
MAQUINA DE LAVAR
BRANCO**



CÓD.	BITOLA	EMBAL.
4400	1/2"	C/12UN

**PARAFUSO FIXAÇÃO
P/ ASSENTO
SANITÁRIO**



CÓD.	DESCRIÇÃO	EMBAL.
5815	PLASTICO	C/12UN

**PINO VEDANTE
P/ TORNEIRA**



CÓD.	BITOLA	EMBAL.
4718	1/2"	C/100UN

**MANGUEIRA ENTRADA
P/ MAQ. LAVAR**



CÓD.	DESCRIÇÃO	EMBAL.
11617	1,40mt	----

**CHUVEIRO C/ BRAÇO
30CM BRANCO 8"**



CÓD.	DESCRIÇÃO	EMBAL.
11649	S/ REGISTRO	----
14873	C/ REGISTRO	----



MARCA DE QUALIDADE

TORNEIRA FILTRO AUTOMÁTICA + ADAPTADOR

CÓD. DESCRIÇÃO EMBAL.
7618 SUPERIOR AZUL C/12UN

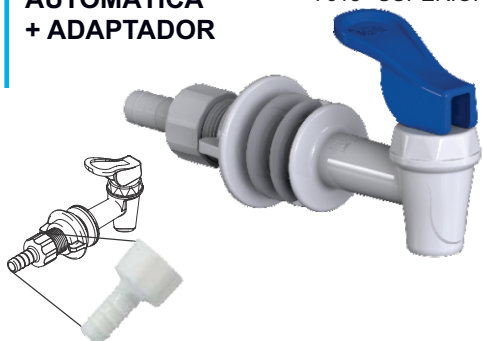

TORNEIRA FILTRO AUTOMÁTICA

CÓD. DESCRIÇÃO EMBAL.
5316 SUPERIOR AZUL C/12UN



TORNEIRA FILTRO AUTOMÁTICA

CÓD. DESCRIÇÃO EMBAL.
5317 INFERIOR AZUL C/12UN



TORNEIRA FILTRO AUTOMÁTICA

CÓD. DESCRIÇÃO EMBAL.
9630 SUPERIOR BR C/12UN



TORNEIRA FILTRO AUTOMÁTICA SUP. PREMIUM

CÓD. DESCRIÇÃO EMBAL.
6614 CROMADA C/12UN



TORNEIRA FILTRO GELAGUA

CÓD. DESCRIÇÃO EMBAL.
8596 BRANCO/AZUL C/12UN



2781

TORNEIRA FILTRO

CÓD. DESCRIÇÃO EMBAL.
4174 BRANCO/PRETO C/12UN



TORNEIRA FILTRO ALAVANCA MANUAL

CÓD. DESCRIÇÃO EMBAL.
4173 MARROM/PRETO C/12UN



TORNEIRA FILTRO GELAGUA

CÓD. DESCRIÇÃO EMBAL.
5313 BRANCO E AZUL C/12UN



2771



R. São José, 508 - Centro - Areal-PB
(83) 3368-1121
ajalesatmc@hotmail.com



MARCA DE QUALIDADE

**TORNEIRA COZINHA
C/ CHUV. BRANCA
1/2"**

CÓD.	DESCRIÇÃO	EMBAL.
5808	10cm	C/12UN
4170	15cm	C/12UN



**TORNEIRA COZINHA
ALAVANCA BRANCA
18CM**

CÓD.	BITOLA	EMBAL.
4142	1/2"	C/12UN



**TORNEIRA BICA
MÓVEL PAREDE
PLUS**

CÓD.	DESCRIÇÃO	EMBAL.
6838	-	C/12UN



**TORNEIRA BICA
MÓVEL PAREDE
PRÁTICA**

CÓD.	DESCRIÇÃO	EMBAL.
6839	-	C/12UN



**TORNEIRA BICA
MÓVEL PAREDE
PLUS BRANCA**

CÓD.	BITOLA	EMBAL.
4403	1/2"	C/12UN



**TORNEIRA BICA
MÓVEL PAREDE
PRÁTICA**

CÓD.	BITOLA	EMBAL.
4404	1/2"	C/12UN



**TORNEIRA LAVATÓRIO
BRANCA**

CÓD.	BITOLA	EMBAL.
4168	1/2"	C/12UN



**TORNEIRA LAVATÓRIO
PLUS BRANCA**

CÓD.	BITOLA	EMBAL.
6836	1/2"	C/12UN



R. São José, 508 - Centro - Areial-PB
(83) 3368-1121
ajalesatmc@hotmail.com



MARCA DE QUALIDADE

TORNEIRA TANQUE BRANCA S/ BICO

CÓD. DESCRIÇÃO EMBAL.

4166	10cm	C/12UN
4169	15cm	C/12UN



TORNEIRA TANQUE BRANCA C/ BICO

CÓD. DESCRIÇÃO EMBAL.

4167	10cm	C/12UN
4172	15cm	C/12UN



TORNEIRA DE JARDIM C/ BICO PRETA

CÓD. BITOLA EMBAL.

4165	1/2"	C/12UN
9083	1/2" E 3/4"	C/12UN



BICO PRETO P/ TORNEIRA JARDIM

CÓD. DESCRIÇÃO EMBAL.

5809	1128-B	C/12UN
------	--------	--------



TORNEIRA LAVAT. BICA ALTA PLUS BRANCA

CÓD. DESCRIÇÃO EMBAL.

9793	MESA	----
------	------	------



TORNEIRA LAVAT. BICA ALTA PRÁTICA BRANCA

CÓD. DESCRIÇÃO EMBAL.

9794	MESA	----
------	------	------



PURIFICADOR C/ BICA MÓVEL PLUS

CÓD. DESCRIÇÃO EMBAL.

8123	BRANCO	----
------	--------	------



TORNEIRA PAREDE BICA MOVEL MARBELLA

CÓD. DESCRIÇÃO EMBAL.

9614	BR/CR	----
------	-------	------



R. São José, 508 - Centro - Areal-PB
(83) 3368-1121
ajalesatmc@hotmail.com



MARCA DE QUALIDADE

**KIT ACESS. P/
BANHEIRO LAVELLO**

CÓD.DESCRICÃO EMBAL.
8531 BRANCO ----

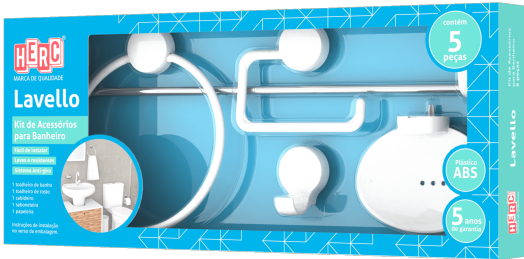

**KIT ACESS. P/
BANHEIRO LAVELLO**

CÓD.DESCRICÃO EMBAL.
8532 BRANCO /
CROMADO ----

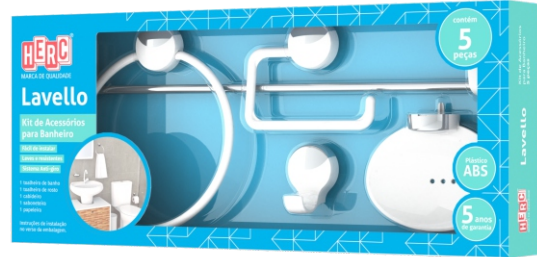

**CAIXA SIF C/ GRELHA
QUADRADO**

CÓD. DESCRICÃO EMBAL.
4401 100X100X40 C/12UN
4712 100X100X50 C/12UN



**CAIXA SIF C/ GRELHA
REDONDO**

CÓD.DESCRICÃO EMBAL.
5321 100X100X40 C/12UN
4713 100X100X50 C/12UN



**CAIXA SIF. C/ GRELHA
QUADRADO**

CÓD.DESCRICÃO EMBAL.
6368 150X150X50 C/06UN
4711 150X175X75 C/06UN



**CAIXA SIF C/ GRELHA
QUADRADA C/ CESTO
E TAMPA**

CÓD. DESCRICÃO EMBAL.
7619 250X250X75X100 C/04UN



**SIFÃO TUBO
EXTENSIVO
38/40/48/50MM**

CÓD. DESCRICÃO EMBAL.
6831 UNIVERSAL ----
6832 DUPLO ----
8595 TRIPLO ----



**RALO LINEAR BRANCO
MODULÁVEL SIFONADO**

CÓD.DESCRICÃO EMBAL.
BRANCO
8987 500MM ----
8988 700MM ----
CINZA
11432 500MM ----

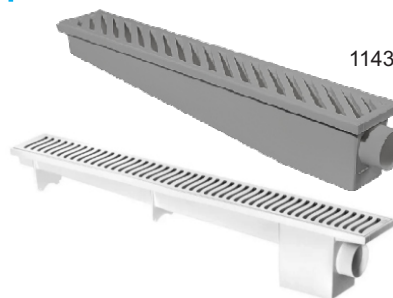

R. São José, 508 - Centro - Areial-PB
(83) 3368-1121
ajalesatmc@hotmail.com



MARCA DE QUALIDADE

**ARMARIO P/ BANHEIRO
ACAB. TRADICIONAL
TIVOLI 356**

CÓD. DESCRIÇÃO EMBAL.

14403	PRETO	----
14872	BRANCO	----



356



353

**ARMARIO P/ BANHEIRO
ACAB. METALIZADO
TIVOLI 360**

CÓD. DESCRIÇÃO EMBAL.

14404	PRETO/	----
-------	--------	------



ACAB. CROMADO

**SABONETEIRA
LAVELLO 4060**

CÓD. DESCRIÇÃO EMBAL.

14405	BRANCO	----
-------	--------	------



**SABONETEIRA TIVOLI
5011**

CÓD. DESCRIÇÃO EMBAL.

14408	BRACO/ CROMADO	----
-------	-------------------	------



**TOALHEIRO ARGOLA
LAVELLO 4070**

CÓD. DESCRIÇÃO EMBAL.

14406	BRANCO	----
-------	--------	------



**PAPELEIRA LAVELLO
BRANCO 4080**

CÓD. DESCRIÇÃO EMBAL.

14407	BRACO/ PLASTICO	----
-------	--------------------	------



**REGISTRO PVC
FACILITA BR C/
VOLANTE**

CÓD. DESCRIÇÃO EMBAL.

14871	CROMADO	----
-------	---------	------



**TORNEIRA LAVAT.
FACILITA**

CÓD. DESCRIÇÃO EMBAL.

14869	BRANCO	----
14870	PRETO	----



R. São José, 508 - Centro - Areal-PB
(83) 3368-1121
ajalesatmc@hotmail.com

**MANGUEIRA
ENTRADA P/
MAQUINA**

CÓD. DESCRIÇÃO EMBAL.

9805	1,20mm	C/12UN
5059	1,40mm	C/12UN
6980	1,80mm	C/12UN
9328	3,00mm	C/12UN

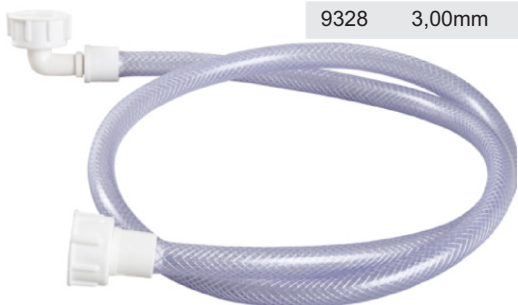

**MANGUEIRA
SAÍDA P/
MAQUINA TRAD.**

CÓD. DESCRIÇÃO EMBAL.

5061	1,40m x 1.1/4"	C/12UN
12955	3/4" x 1.1/4"	C/12UN



**MANGUEIRA DE
ENTRADA P/ MAQ.**

CÓD. BITOLA EMBAL.

15151	3,00MT	C/ 12UN
-------	--------	---------

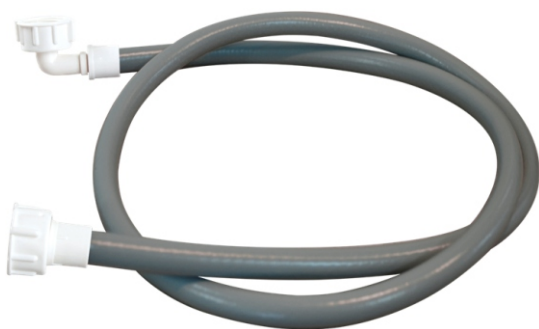

**MANGUEIRA
SAÍDA P/ TANQUE**

CÓD. DESCRIÇÃO EMBAL.

5060	1,10m	C/ 12UN
------	-------	---------



**ENGATE RÁPIDO LJ
C/ CONEXÃO**

CÓD. BITOLA EMBAL.

9333	1/2	C/24
------	-----	------



**ESGUICHO LUXO
P/ MANG.**

CÓD. BITOLA EMBAL.

5295	7/6" OU 1/2"	C/ 12UN
------	--------------	---------



**ESGUICHO GATILHO
LJ MEGAJATO**

CÓD. BITOLA EMBAL.

5304	7/6" OU 1/2"	C/ 24UN
------	--------------	---------



**TORNEIRA JARDIM
PRETO**

CÓD. BITOLA EMBAL.

9336	1/2"	C/12UN
------	------	--------



**SUPORTE PLAST.
MANGUEIRA**

CÓD. DESCRIÇÃO EMBAL.

6102	LARANJA	C/ 12 UN
6101	PRETO	C/ 12 UN
9330	AZUL	C/ 12 UN



**KIT ACESSORIO
BANHEIRO 5 PÇS**

CÓD. DESCRIÇÃO EMBAL.

11864	BRANCO	-----
-------	--------	-------





CURVA 180°

CÓD.	BITOLA	EMBAL.
8613	3/4"	C/10



CURVA 90° CURTA

CÓD.	BITOLA	EMBAL.
9332	1"	C/10
8529	3/4"	C/10



CURVA 90° LONGA

CÓD.	BITOLA	EMBAL.
9331	1"	C/10
8530	3/4"	C/10



ENGATE FLEXIVEL

CÓD.	DESCRIÇÃO	EMBAL.
9325	40 cm	C/12
9326	50 cm	C/12
9327	60 cm	C/12



BANDEJA P/ PINTURA 23 CM

CÓD.	DESCRIÇÃO	EMBAL.
9324	PRETO	C/ 06



ADAPTADOR ROSCA EXTERNA

CÓD.	BITOLA	EMBAL.
9265	1/2"	C/ 50
9266	3/4"	C/ 50
9267	1"	C/ 25



ADAPTADOR ROSCA INTERNA

CÓD.	BITOLA	EMBAL.
14580	1/2"	C/ 50
9264	3/4"	C/ 50



ADAPTADOR REDUÇÃO

CÓD.	BITOLA	EMBAL.
9268	1" X 3/4"	C/ 25
11451	3/4" X 1/2"	C/ 25



JOELHO INTERNO 90°

CÓD.	DESCRIÇÃO	EMBAL.
9274	1/2"	C/25UN
14590	3/4"	C/25UN
9275	1"	C/25UN



R. São José, 508 - Centro - Areial-PB
 (83) 3368-1121
 ajalesatmc@hotmail.com

TE INTERNO TRIPLO 90°



CÓD.	DESCRIÇÃO	EMBAL.
9269	1/2"	C/25UN
9270	3/4"	C/25UN
9279	1"	C/25UN

TE INTERNO TRIPLO AZUL



CÓD.	DESCRIÇÃO	EMBAL.
11211	1/2"	C/ 25
11212	3/4"	C/ 25
11219	1"	C/ 25

UNIÃO INTERNA PRETO



CÓD.	DESCRIÇÃO	EMBAL.
9272	1/2"	C/50UN
9273	3/4"	C/50UN
9271	3/8"	C/50UN
14583	1"	C/25UN

UNIAO INTERNA AZUL



CÓD.	DESCRIÇÃO	EMBAL.
11213	1/2"	C/ 50
11214	3/4"	C/ 50
14587	1"	C/ 25
14596	1.1/4X1"	C/ 10
14597	1.1/2X1.1/4"	C/ 10

TE INTERNO 90°



CÓD.	DESCRIÇÃO	EMBAL.
9276	1/2"	C/25UN
9277	3/4"	C/25UN
9278	1"	C/25UN
14591	1.1/2"	C/10UN

TE INTERNO AZUL



CÓD.	DESCRIÇÃO	EMBAL.
11216	1/2"	C/ 25
11217	3/4"	C/ 25
11218	1"	C/ 25
14593	1.1/2"	C/ 10

UNIAO REDUÇÃO AZUL



CÓD.	DESCRIÇÃO	EMBAL.
14588	3/4"X1/2"	C/ 25
14589	1"X3/4"	C/ 25

JOELHO INTERNO AZUL



CÓD.	DESCRIÇÃO	EMBAL.
14592	3/4"	C/ 25
11215	1"	C/ 25

ADAPTADOR "R" INTERNA AZUL



CÓD.	DESCRIÇÃO	EMBAL.
14584	1/2"	C/ 50

ADAPTADOR "R" EXTERNA AZUL



CÓD.	DESCRIÇÃO	EMBAL.
11209	3/4"	C/ 50
11210	1"	C/ 25



**JOELHO INTERNO
DUPLO PRETO**

CÓD.	DESCRIÇÃO	EMBAL.
14581	1/2"	C/ 25
14582	3/4"	C/ 25
14594	1"	C/ 25



**JOELHO INTERNO
DUPLO AZUL**

CÓD.	DESCRIÇÃO	EMBAL.
14585	1/2"	C/ 25
14586	3/4"	C/ 25
14596	1"	C/ 25



**ADAPTADOR SOLD.
P/ CX D'AGUA**

CÓD.	DESCRIÇÃO	EMBAL.
12861	20mm	C/10UN
12862	25mm	C/10UN
12863	32mm	C/05UN
12864	40mm	C/05UN
12865	50mm	C/04UN



**TORNEIRA CHUVEIRO
PIA 15CM**

CÓD.	DESCRIÇÃO	EMBAL.
12866	1/2"	C/12UN



**TORNEIRA CHUVEIRO
TANQUE 10CM**

CÓD.	DESCRIÇÃO	EMBAL.
12867	1/2"	C/12UN



**MANG. DUPLAFLEX
1/2"X1,70mm**

CÓD.	DESCRIÇÃO	EMBAL.
6103	AZUL	RL C/50MT
6104	VERDE	RL C/50MT



**MANG. JARDIM
DUPLAFLEX AZUL**

CÓD.	DESCRIÇÃO	EMBAL.
9316	10 MT	----
9317	15 MT	----
9318	20 MT	----
9319	30 MT	----



**MANG. JARDIM
DUPLAFLEX VERDE**

CÓD.	DESCRIÇÃO	EMBAL.
9320	10 MT	----
9321	15 MT	----
9322	20 MT	----
9323	30 MT	----



**MANGUEIRA
PT 300**

CÓD.	DESCRIÇÃO	EMBAL.
9329	5/16"	C/50 MT
12860	1/4"	C/50 MT



R. São José, 508 - Centro - Areial-PB
(83) 3368-1121
ajalesatmc@hotmail.com

**ARMARIO
P/ BANHEIRO**

CÓD.	DESCRIÇÃO	EMBAL.
6099	BEGE	C/03UN
5297	BRANCO	C/03UN
5299	CARAMELO	C/03UN
5298	CINZA	C/03UN



BRANCO



CINZA



BEGE



CARAMELO

**TORNEIRA BÓIA
P/ CAIXA DE ÁGUA**

CÓD.	BITOLA	EMBAL.
5065	1/2" e 3/4"	C/12UN



**TAMPA P/
VÁLVULA DE PIA
E LAVATÓRIO**

CÓD.	DESCRIÇÃO	EMBAL.
5062	T1	C/100UN



**SIFÃO EXTENSIVO
UNIVERSAL C/ ANEL**

CÓD.	DESCRIÇÃO	EMBAL.
11537	50 cm	C/36UN
5301	72 cm	C/36UN
10046	1,50 mt	C/18UN



**SIFÃO EXTENSIVO
C/ ANEL**

CÓD.	DESCRIÇÃO	EMBAL.
5302	DUPLO	C/10UN



**SIFÃO EXTENSIVO
C/ ANEL**

CÓD.	DESCRIÇÃO	EMBAL.
8427	TRIPLO	C/10UN

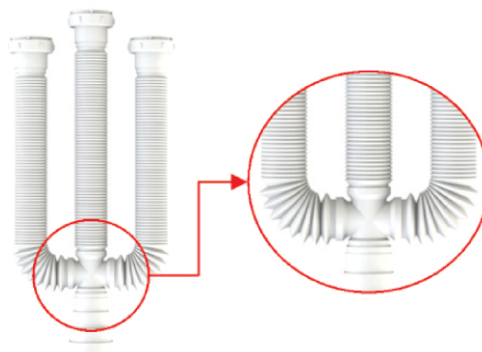

**TAMPA P/
VÁLVULA DE
TANQUE**

CÓD.	DESCRIÇÃO	EMBAL.
5087	T2	C/100UN



**SPUDE P/
VASO SANITÁRIO**

CÓD.	DESCRIÇÃO	EMBAL.
5303	BRANCO	C/12UN



**VÁLVULA V8 P/
TANQUE E
LAVATÓRIO**

CÓD.	BITOLA	EMBAL.
8200	1" (7/8")	C/20UN



**MANGUEIRA CRISTAL
TRANSPARENTE
C/ 50MT**



CÓD.	BITOLA	EMBAL.
7642	1/4" x 1,5	----
7641	1/4" x 2,0	----
7639	1/2" x 1,5	----
7640	1/2" x 2,0	----
7638	1/4" x 1,0	----
7646	5/16" x 1,0	----
7647	5/16" x 1,5	----
7643	3/4" x 1,5	----
7644	3/4" x 2,0	----
7645	3/4" x 2,5	----
7648	1" x 2,0	----
7649	1" x 2,5	----
7650	1" x 3,0	----

**MANGUEIRA JARDIM
TRANÇADA
QUALITRANCE**



CÓD.	DESCRIÇÃO	EMBAL.
8156	AZUL - 10mt	C/20UN
8160	VERDE - 10mt	C/20UN
8157	AZUL - 15mt	C/14UN
8161	VERDE - 15mt	C/ 14UN
8158	AZUL - 20mt	C/10UN
8162	VERDE - 20mt	C/10UN
8159	AZUL - 30mt	C/08UN
8163	VERDE - 30mt	C/08UN



**MANGUEIRA JARDIM
QUALIPOP**



CÓD.	DESCRIÇÃO	EMBAL.
8150	VERDE - 10mt	C/20UN
8153	AZUL - 10mt	C/20UN
8151	VERDE - 15mt	C/14UN
8154	AZUL - 15mt	C/ 14UN
8152	VERDE - 20mt	C/10UN
8155	AZUL - 20mt	C/10UN



**MANGUEIRA
TRANÇADA
TRANSPARENTE
PT 205 PSI**



CÓD.	BITOLA	EMBAL.
7635	1/2"	C/50MT
7636	3/4"	C/50MT
7637	1"	C/50MT



**MANGUEIRA 2,5
SILICONADA TRANSP.
(COMBUSTIVEL)**



CÓD.	BITOLA	EMBAL.
9178	5"	C/50MT
9179	7"	C/50MT

**MANGUEIRA DUPLA
CAMADA**



CÓD. DESCRIÇÃO EMBAL.

AZUL

11768	1/2"x1,5	RL C/50MT
11770	1/2"x2,0	RL C/50MT
11777	3/4"x1,5	RL C/50MT
11771	3/4"x2,0	RL C/50MT
11775	1"x2,0	RL C/50MT

VERDE

11769	1/2"x1,5	RL C/50MT
12773	1/2"x2,0	RL C/50MT
11776	3/4"x1,5	RL C/50MT
11772	3/4"x2,0	RL C/50MT
11773	1"x2,5	RL C/50MT
11774	1"x3,0	RL C/50MT



LORENZETTI

Mais do que você imagina

CHUVEIRO ELÉTRICO BELO BANHO C/ CANO

CÓD. DESCRIÇÃO EMBAL.
6976 220V/4600W C/08



DUCHA TOP JET MULT TEMPERATURA

CÓD. DESCRIÇÃO EMBAL.
10475 220V/6400W C/04



CHUVEIRO ELET. MAXI DUCHA S/ CANO

CÓD. DESCRIÇÃO EMBAL.
6975 200V/3200W C/21



CANO P/ CHUVEIRO

CÓD. DESCRIÇÃO EMBAL.
6974 BRANCO C/10



CHUVEIRO ELET. MAXI BANHO ULTRA C/ CANO 220V

CÓD. DESCRIÇÃO EMBAL.
8747 4600W C/08



REFIL P/ ACQUA BELLA/VITA

CÓD. DESCRIÇÃO EMBAL.
6972 - C/06



PURIFICADOR DE AGUA/ TOR ACQUA BELLA

CÓD. DESCRIÇÃO EMBAL.
8747 BRANCO C/04



CHUVEIRO ELET. MAXI BANHO ULTRA S/ CANO 220V

CÓD. DESCRIÇÃO EMBAL.
8746 4600W C/21



TRAMONTINA

ADAPTADOR PLAST, C/ ENGATE ROSQ. 1/2"

CÓD. DESCRIÇÃO EMBAL.
11226 MANG. JARDIM ----



ESGUICHO PLAST. ROSQ. E JATO REG. P/ JARDIM

CÓD. DESCRIÇÃO EMBAL.
11227 C/ ENGATE ----



MANG. ESPECIAL FLEX EM PVC

CÓD. DESCRIÇÃO EMBAL.
11231 P/ JARDIM RL C/ 200MT



SUPORTE FIXO MENOR EM PLAST. P/ MANG. DE 1/2"

CÓD. DESCRIÇÃO EMBAL.
11228 ATÉ 35MT ----



TORNEIRA PLASTICA C/ REDUÇÃO

CÓD. DESCRIÇÃO EMBAL.
11225 P/ JARDIM ----



PLASTUNING

SIFAO EXT. UNIVERSAL FLEX

CÓD. DESCRIÇÃO EMBAL.
12888 50 CM ----



SIFÃO EXT. DUPLO FLEX

CÓD. DESCRIÇÃO EMBAL.
12887 BRANCO ----



R. São José, 508 - Centro - Areial-PB
(83) 3368-1121
ajalesatmc@hotmail.com

REGISTRO DE PRESSÃO C/ CANOPLA V-33

CÓD.	DESCRIÇÃO	EMBAL.
8650/14134	1/2	C/06 UN
8652	3/4	C/06 UN



REGISTRO DE PRESSÃO C/ CANOPLA V-44

CÓD.	DESCRIÇÃO	EMBAL.
8651	1/2	C/06 UN
8663	3/4	C/06 UN



TORNEIRA B. MOVEL P/ LAVAT. - LIGHT 1/2"

CÓD.	DESCRIÇÃO	EMBAL.
8671	V-33	C/06 UN
8661	V-44	C/06 UN
14135	C-44	C/06 UN



TORNEIRA B. MOVEL P/ LAVAT. - LIGHT V-44

CÓD.	DESCRIÇÃO	EMBAL.
8659	1/2	C/06 UN



TORNEIRA PIA COZ 18CM V-33 C/ BUCHA 1158

CÓD.	DESCRIÇÃO	EMBAL.
8649/8670	1/2	C/06 UN



TORNEIRA B. MOVEL PAREDE P/PIA COZINHA LIGHT V-44

CÓD.	DESCRIÇÃO	EMBAL.
8655	1/2	C/06 UN



TORNEIRA B. MOVEL PAREDE P/PIA COZINHA LIGHT V-33

CÓD.	DESCRIÇÃO	EMBAL.
8654	1/2	C/06 UN



TORNEIRA PIA COZ. LONGA 22CM C/ BUCHA V33 1159

CÓD.	DESCRIÇÃO	EMBAL.
11013/	1/2	C/06 UN
11024		



REGISTRO DE PRESSÃO C/ CANOPLA LET V-25 1416

CÓD.	DESCRIÇÃO	EMBAL.
9260	1/2	-----
9261	3/4	-----



CABEÇOTE MV 1416

CÓD.	DESCRIÇÃO	EMBAL.
9259/ 11025	3/8"	----



TORNEIRA BICA MOVEL LAVATORIO LET L-25

CÓD.	DESCRIÇÃO	EMBAL.
9263	1/2	-----



TORNEIRA BICA MOVEL LAVATORIO V-33

CÓD.	DESCRIÇÃO	EMBAL.
8658	1/2	----



TORNEIRA B. MOVEL MESA P/PIA COZINHA LIGHT V-44

CÓD.	DESCRIÇÃO	EMBAL.
8656/ 12787	1/2	-----



TORNEIRA BICA MOVEL PAREDE P/ PIA LET L-25

CÓD.	DESCRIÇÃO	EMBAL.
9262	1/2	-----



TORNEIRA BICA MOVEL PAREDE P/ PIA E COZ. LIGHT 1/2 COD.162

CÓD.	DESCRIÇÃO	EMBAL.
11018/ 11022	C-44	-----



REGISTRO GAVETA LUXO C-44 1509

CÓD.	DESCRIÇÃO	EMBAL.
11016/ 11026	3/4"	C/06 UN



REGISTRO GAVETA LUXO C-50 1509

CÓD.	DESCRIÇÃO	EMBAL.
11017/ 11027	3/4"	C/06 UN



REGISTRO PRESSAO V44 C/ CANOPLA 1416

CÓD.	DESCRIÇÃO	EMBAL.
8664	1/2"	C/06 UN
8666	3/4"	C/06 UN



REGISTRO PRESSAO V50 C/ CANOPLA 1416

CÓD.	DESCRIÇÃO	EMBAL.
11014/ 11020	1/2"	C/06 UN
11015/ 11021	3/4"	C/06 UN



TORNEIRA BICA MÓVEL PAREDE C-50 P/ PIA COZ. LIGHT 162

CÓD.	DESCRIÇÃO	EMBAL.
11019/ 11023	1/2"	C/06 UN



TORNEIRA BICA MÓVEL PAREDE V33 P/ PIA COZ. LIGHT 162

CÓD.	DESCRIÇÃO	EMBAL.
8660	1/2"	C/06 UN



TORNEIRA BICA MÓVEL PAREDE 1/2" P/ PIA COZ. LIGHT 162

CÓD.	DESCRIÇÃO	EMBAL.
8668	V44	C/06 UN
14136	C-59	C/06 UN



**TORNEIRA BICA
MOVEL MESA P/
LAVAT. 1/2 LIGHT
COD.195**

CÓD. DESCRIÇÃO EMBAL.

12791/
12796

C-59

C/06



1/4 VOLTA

**TORNEIRA BICA
MOVEL MESA P/
PIA COZINHA 1/2
LIGHT COD.163**

CÓD. DESCRIÇÃO EMBAL.

12786

C-59

C/06



1/4 VOLTA

**TORNEIRA BICA
MOVEL MESA P/
PIA COZINHA 1/2
COD.163**

CÓD. DESCRIÇÃO EMBAL.

12800/
12801

VA-50

C/06



1/4 VOLTA

**TORNEIRA BICA
MOVEL LAVATORIO
1/2 V-50**

CÓD. DESCRIÇÃO EMBAL.

12792/
12803

V-50

C/06



**TORNEIRA BICA
MOVEL PAREDE P/
PIA COZINHA 1/2
LIGHT COD.162**

CÓD. DESCRIÇÃO EMBAL.

12784/
12794

C-59

C/06



1/4 VOLTA

**TORNEIRA BICA
MOVEL PAREDE
PI 1/2 COD.162**

CÓD. DESCRIÇÃO EMBAL.

12785/
12802

V-50

C/06



**TORNEIRA LAVAT.
LUXO LIGHT 1/2
COD.194**

CÓD. DESCRIÇÃO EMBAL.

8657/
8669

V-44

C/06



DUCHA HIGIÊNICA FLEX LIGHT 1,20MT 1/2

CÓD. DESCRIÇÃO EMBAL.

12789/ 12799	V-44	----
12790/ 12798	V-50	----
12788/ 12797	C-59	----



AREJADOR

CÓD.	DESCRIÇÃO	EMBAL.
10698	P/ TORNEIRA	C/12



VEDA ROSCA 12MM

CÓD. DESCRIÇÃO EMBAL.

7748	5m	C/120UN
7749	10m	C/120UN
7750	25m	C/60UN

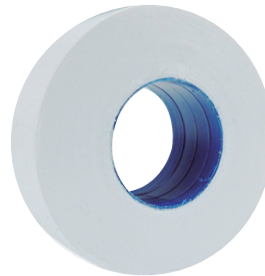

VÁLVULA METAL FUNDO DE POÇO

CÓD.	BITOLA	EMBAL.
7004	3/4"	C/30UN



VALVULA AMERICANA C/ VEDA ROSCA ABS 3.1/2"

CÓD. DESCRIÇÃO EMBAL.

8890	CROMADO	-----
------	---------	-------



VÁLVULA DE RETENÇÃO VERTICAL

CÓD.	BITOLA	EMBAL.
6931	1/2"	C/50UN
7005	3/4"	C/30UN
8912	1"	-----

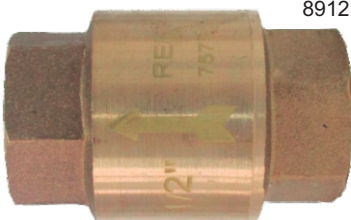

ADESIVO VEDACALHA



CÓD.	DESCRIÇÃO	EMBAL.
6689	285G	C/12UN

ANEL DE VEDAÇÃO P/ VASO



CÓD.	DESCRIÇÃO	EMBAL.
6692	-	C/12UN

COLA CANO

CÓD.	DESCRIÇÃO	EMBAL.
6693	17G	C/48UN
6694	75G	C/30UN



COLA CANO POTE



CÓD.	DESCRIÇÃO	EMBAL.
7985	175G	C/12UN

COLA CANO RAP.



CÓD.	DESCRIÇÃO	EMBAL.
8320	850G	C/12UN

VEDA ROSCA



CÓD.	DESCRIÇÃO	EMBAL.
6691	12mmX10mt	C/60UN
6699	12mmX25mt	C/30UN
7986	18mmX25mt	C/30UN
8321	18mmX50mt	C/30UN

GhelPlus
ambientes com estilo

PIA INOX CONC./ESC./ BALI/30200

CÓD.	DESCRIÇÃO	EMBAL.
9207	1,20 MT	----
9208	1,40 MT	----
9209	1,50 MT	----
9210	1,60 MT	----



R. São José, 508 - Centro - Areal-PB
(83) 3368-1121
ajalesatmc@hotmail.com

CHUVEIRO C/ BRAÇO

CÓD.DESCRICÃO EMBAL.

CROMADO

5657	4"	----
5659	6"	----
5661	9"	----

BRANCO

5658	4"	----
5660	6"	----



KIT SALVA TOMADA C/ PARAF.

CÓD.DESCRICÃO EMBAL.

CROMADO

15202	4X2	----
15203	4X4	----

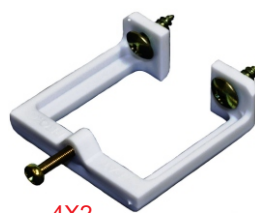

4X2

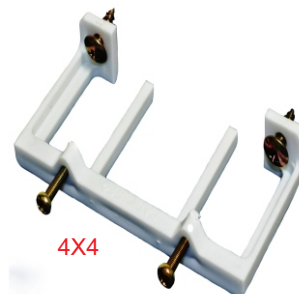

4X4

ASTRA

CONJ. FECHAMENTO BOIA

CÓD. DESCRICÃO EMBAL.

15051 P/ MECANISMO C/06



VALVULA LAVAT. S/ LADRÃO E UNHO

CÓD.DESCRICÃO EMBAL.

15059 PRETO C/25



SIFÃO SANFONADO UNIVERSAL

CÓD.DESCRICÃO EMBAL.

15053 PRETO C/10



BOLSA EXCENTRICA P/ SAIDA DE BACIA

CÓD.DESCRICÃO EMBAL.

15038 4" C/10



MECANISMO DUPLO HIDRAULICA

CÓD.DESCRICÃO EMBAL.

15199 SAIDA E ENTRADA ----



MECANISMO DUPLO ACIONAMENTO

CÓD.DESCRICÃO EMBAL.

15200 C/ BOTÃO ----
DUPLO
ACIONAMENTO



ASTRA

FILTRO CAVALETE P/ AGUA

CÓD.DESCRICÃO EMBAL.
15045 BRANCO C/06



REFIL P/ FILTRO P/ AGUA

CÓD.DESCRICÃO EMBAL.
15046 CAVALETE C/06

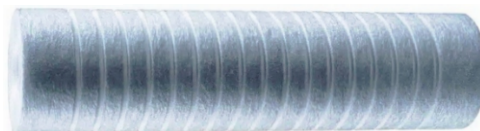

FILTRO P/ AGUA 9 3/4 PIA

CÓD.DESCRICÃO EMBAL.
15047 BRANCO C/06



REFIL P/ FILTRO P/ AGUA 9 3/4 PIA

CÓD.DESCRICÃO EMBAL.
15048 CARBON-B C/06



BOCAL PVC DE SAIDA CALHA

CÓD.DESCRICÃO EMBAL.
15039 100MM C/06



CABECEIRA P/ CALHA

CÓD.DESCRICÃO EMBAL.
15040 BRANCO C/10



EMENDA DA CALHA

CÓD.DESCRICÃO EMBAL.
15041 S/ VENDAÇÃO C/10



SUPORTE DE FIXAÇÃO

CÓD.DESCRICÃO EMBAL.
15042 P/ CALHA C/20



SUPORTE TORCIDO PROLONGADOR

CÓD.DESCRICÃO EMBAL.
15043 P/ CALHA C/20



R. São José, 508 - Centro - Areial-PB
(83) 3368-1121
ajalesatmc@hotmail.com

ASTRA

ARMARIO P/ BANHEIRO VERSATIL

CÓD.	COR	EMBAL.
6800	BRANCO	C/06
6802	CARAMELO	C/06
6804	CINZA CLARO	C/06
9675	PRETO	C/06



ARMARIO P/ BANHEIRO PERFIL ALUMINIO VERSATIL AI41

CÓD.	COR	EMBAL.
14412	BRANCO	C/06
14413	CZ. CLARO	C/06



INTERIOR ESPELHADO

31X36X10

ARMÁRIO PLASTICO C/ DIVISORES

CÓD.	DESCRIÇÃO	EMBAL.
	32X46,5 CM	
11919	A23BR1	C/ 04
11980	A23CZ2	C/ 04
	28,5X41,0 CM	
10064	A21BR1	C/ 06

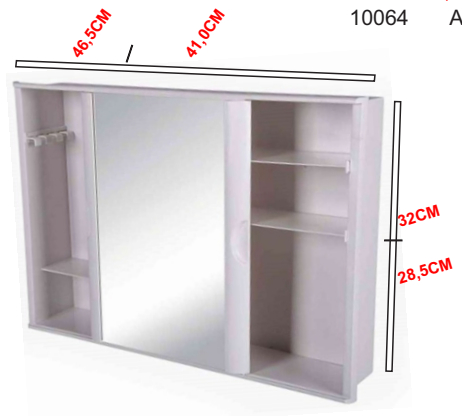

REPARO P/ CX. ACOPLADA NATURAL

CÓD.	DESCRIÇÃO	EMBAL.
10881	----	C/ 06

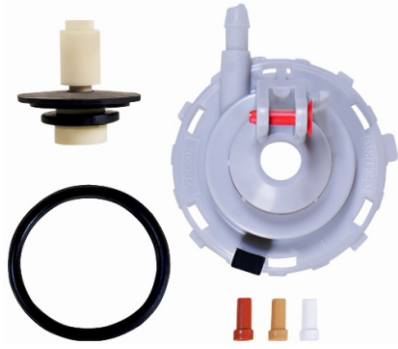

BICA CALHA PLASTICA

CÓD.	DESCRIÇÃO	EMBAL.
7539	3MT	----



TANQUE PLAST. P/ LAVAR ROUPA 47x43x27

CÓD.	DESCRIÇÃO	EMBAL.
14438	22LT	----



LAVATORIO PLASTICO C/ VALVULA 3,8LT 36X28CM

CÓD.	DESCRIÇÃO	EMBAL.
9681	BRANCO	----
11981	CINZA	----



R. São José, 508 - Centro - Areial-PB
 (83) 3368-1121
 ajalesatmc@hotmail.com

ASTRA

**CAIXA DESCARGA
CONTROL. ATÉ 9 LT
C17/S**



CÓD.	COR	EMBAL.
6795	BRANCO	C/10
9676	BEGE	C/05
6797	CARAM. CLARO	C/05
6796	CARAM. ESCURO	C/05
6799	CINZA CLARO	C/05
6798	CINZA ESCURO	C/05
14415	PRETO	C/05

**ASSENTO SANITARIO
VERSATO ALMOF.
TVT/K**



CÓD.	COR	EMBAL.
14439	BRANCO	C/06
14440	CINZA	C/06
14441	PRETO	C/06

**ASSENTO SANIT.
POP TPG AS/BR1**



CÓD.	DESCRIÇÃO	EMBAL.
12118	BRANCO	C/06

**ASSENTO SANITARIO
ALMOFADADO TPK**



CÓD.	COR	EMBAL.
6815	BRANCO	C/10
6819	CZ. CLARO	C/05
6818	CZ. ESCURO	C/05
9691	PRETO	C/05
6817	CARAM. CLARO	C/05
6816	CARAM. ESCURO	C/05

**ASSENTO SANITARIO
PLUS TPR**



CÓD.	COR	EMBAL.
9692	BEGE	C/06
9693	BRANCO	C/06
9694	CARAM. CLARO	C/06
14436	CARAM. ESCURO	C/06
9695	CINZA CLARO	C/06
14437	CINZA ESCURO	C/06

**ASSENTO SANITARIO
SOFT TPJ**



CÓD.	COR	EMBAL.
6810	BRANCO	C/12
6812	CARAM. CLARO	C/06
6811	CARAM. ESCURO	C/06
6814	CINZA CLARO	C/06
6813	CINZA ESCURO	C/06
9690	BEGE	C/06
11920	PRETO	C/06

ASTRA

**CAIXA SIFONADA
3 ENTRADAS QUAD.
CROMADA Cs2**

CÓD. DESCRIÇÃO EMBAL.
9677 10X12 C/05



40X50X100

**CAIXA SIFONADA
7 ENTR. QUAD.CROMADA
CS6/B**

CÓD. DESCRIÇÃO EMBAL.
9678 15X15 C/12



GRELHA ROTATIVA

40X50X100

**CAIXA SIFONADA
3 ENTRADAS QUAD.
BRANCO Cs1**

CÓD. DESCRIÇÃO EMBAL.
14417 10X12 C/05



40X50X100

**CAIXA SIFONADA
3 ENTRADAS QUAD.
BRANCO CS1/B**

CÓD. DESCRIÇÃO EMBAL.
14418 10X12 C/12



GRELHA ROTATIVA

40X50X100

**CAIXA SIFONADA
3 ENTRADAS QUAD.**

CÓD. DESCRIÇÃO EMBAL.
14419 10X12 C/05



GRELHA DE
ALUMINIO

40X50X100

**CAIXA SIFONADA
3 ENTRADAS QUAD.
CROM. CS2/B**

CÓD. DESCRIÇÃO EMBAL.
14420 10X12 C/12



GRELHA ROTATIVA

40X50X100

**RALO SIFONADO
REDONDO**

CÓD. COR EMBAL.
9683 BRANCO C/30



**RALO SIFONADO
QUADRADO SUP. C/
GRELHA REDONDO**

CÓD. COR EMBAL.
9684 BRANCO C/30



R. São José, 508 - Centro - Areial-PB
(83) 3368-1121
ajalesatmc@hotmail.com



SIFÃO SANFONADO UNIVERSAL

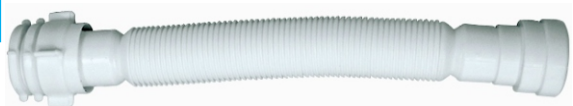

COMPACTO

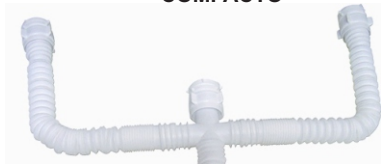

TRIPLO

CÓD.	COR	EMBAL.
9686	COMPACTO	C/10
9685	DUPLO	C/10
9687	TRIPLO	C/06

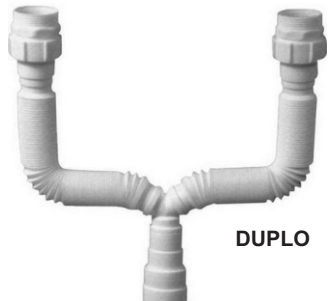

DUPLO

TORNEIRA BÓIA HASTE ALUMINIO

CÓD.	DESCRIÇÃO	EMBAL.
9688	1/2"	C/15
6809	1/2" e 3/4"	C/15



TORNEIRA BÓIA P/ BEBEDOURO

CÓD.	DESCRIÇÃO	EMBAL.
9689	1/2"	C/10



BOIA CONJUNTO FECHAMENTO P/ MECANISMO

CÓD.	DESCRIÇÃO	EMBAL.
10883	----	C/06



VALVULA P/ LAVATORIO S/ LADRÃO S/ UNHO

CÓD.	DESCRIÇÃO	EMBAL.
9697	CROMADO	C/25



VALVULA P/ LAVATORIO S/ LADRÃO S/ UNHO

CÓD.	DESCRIÇÃO	EMBAL.
9696	BRANCO	C/25



VALVULA DE POÇO PLASTICO MARRON

CÓD.	DESCRIÇÃO	EMBAL.
6820	1"	C/08



TAMPA P/ VALVULA 25MM V91T

CÓD.	DESCRIÇÃO	EMBAL.
14401	PIA/LAVAT.	----



R. São José, 508 - Centro - Areial-PB
 (83) 3368-1121
 ajalesatmc@hotmail.com

**ANEL DE VEDAÇÃO
P/ BACIA SANIT.**

CÓD. DESCRIÇÃO EMBAL.
10866 S/ GUIA ----



**ANEL DE VEDAÇÃO
P/ BACIA SANIT.**

CÓD. DESCRIÇÃO EMBAL.
10867 C/ GUIA ----



**BRAÇO P/ CHUVEIRO
ELETRICO CR.**

CÓD. DESCRIÇÃO EMBAL.
10868 30 CM C/ 12



**BRAÇO P/ CHUVEIRO
BR. C/ CAPA**

CÓD. DESCRIÇÃO EMBAL.
10869 40 CM C/ 06



**BRAÇO P/ CHUVEIRO
ELETRICO**

CÓD. DESCRIÇÃO EMBAL.
6805 30 CM C/12



CHUVEIRO PLASTICO

CÓD. COR EMBAL.
9679 BRANCO C/12

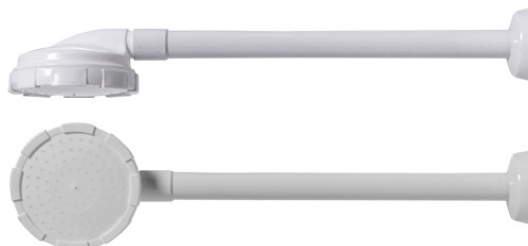

**ENGATE METALIZADO
1/2"**

CÓD. DESCRIÇÃO EMBAL.
10874 40 CM C/ 10
10875 50 CM C/ 10
10876 60 CM C/ 10



ENGATE BRANCO

CÓD. DESCRIÇÃO EMBAL.
6806 30CM C/10
6807 40CM C/10
6808 50CM C/10
9680 60CM C/10
14421 80CM C/10
10873 100CM C/10



**VEDANTE SILICONE
P/ CX. DESCARGA**

CÓD. DESCRIÇÃO EMBAL.
10870 C15-17 C/ 12



**BOLSA DE VEDAÇÃO
P/ SAIDA D'AGUA**

CÓD. DESCRIÇÃO EMBAL.
10884 ---- C/ 14



ROLETE P/ PAPEL HIGIENICO

CÓD. DESCRIÇÃO EMBAL.
10886 ---- C/ 10



SIFÃO SANFONADO UNIVERSAI

CÓD. DESCRIÇÃO EMBAL.
10887 CROMADO C/ 10



CONJUNTO FIXAÇÃO P/ ASSENTO SANIT. TPJ

CÓD. DESCRIÇÃO EMBAL.
10888 PLASTICO C/ 20



CONJUNTO CESTO P/ VALVULA

CÓD. DESCRIÇÃO EMBAL.
10889 CROMADO C/ 15



VALVULA CLICK CROMADA

CÓD. DESCRIÇÃO EMBAL.
10890 1.1/4" C/ 04



VALVULA CLICK C/ CAPA INOX

CÓD. DESCRIÇÃO EMBAL.
10891 1.1/4" C/ 04



VALVULA PÉ DE POÇO PLASTICO MARROM

CÓD.	DESCRIÇÃO	EMBAL.
6821	3/4"	C/ 08
6820	1"	C/ 08
10892	1.1/2"	C/ 06
10893	1.1/4"	C/ 06
10894	2"	C/ 06



VALVULA DE RETENÇÃO PP

CÓD.	DESCRIÇÃO	EMBAL.
10895	1"	C/ 06
10896	3/4"	C/ 08



FECHO HIDRICO REM. CG MOD. 2 CX. SIFONADA

CÓD. DESCRIÇÃO EMBAL.
10872 15X18 C/ 06



FECHO HIDRICO CX. SIFONADA MOD. 2 CS1/FH2

CÓD. DESCRIÇÃO EMBAL.
10871 CS 10X12 C/ 06



**GRELHA ROTATIVA
QUAD. BRANCO**

CÓD. DESCRIÇÃO EMBAL.
10877 9,4X 9,4 CM C/ 16

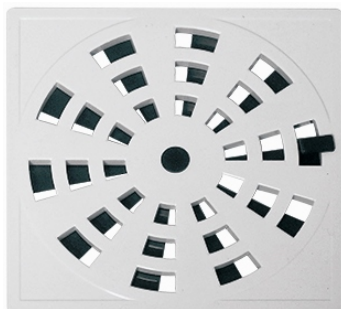

**GRELHA ROTATIVA
RED. BRANCO**

CÓD. DESCRIÇÃO EMBAL.
10878 9,7 CM C/ 16



**ENTRADA D'AGUA
UNIVERSAL**

CÓD. DESCRIÇÃO EMBAL.
15050 UNIVERV. C/06
MOD. 2

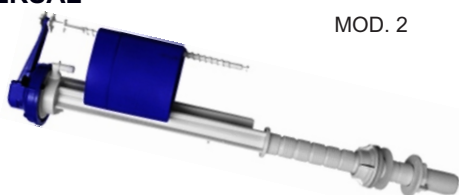

**MECANISMO COMPLETO
UNIVERSAL SUPERIOR
C/ BOIA**

CÓD. DESCRIÇÃO EMBAL.
9682 ----- C/03



**ENTRADA D'AGUA
NATURAL**

CÓD. DESCRIÇÃO EMBAL.
10882 300MM C/ 06



**ENTRADA D'AGUA
UNIVERSAL**

CÓD. DESCRIÇÃO EMBAL.
15049 UNIVERV. C/06

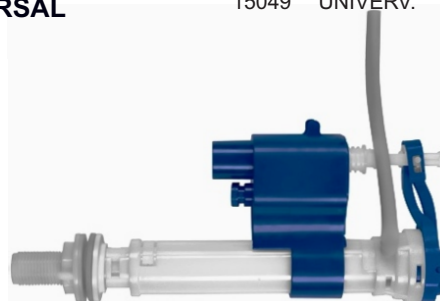

**CONJUNTO CASTELO
ACION. CX. ACOPLADA**

CÓD. DESCRIÇÃO EMBAL.
10885 ----- C/ 12



**ENTRADA D'AGUA
HIDRAULICA MOD.2**

CÓD. DESCRIÇÃO EMBAL.
10879 C/ 300MM C/ 06



**MECANISMO COMPLETO
UNIVERSAL**

CÓD. DESCRIÇÃO EMBAL.
15052 C/ HEU2 C/03

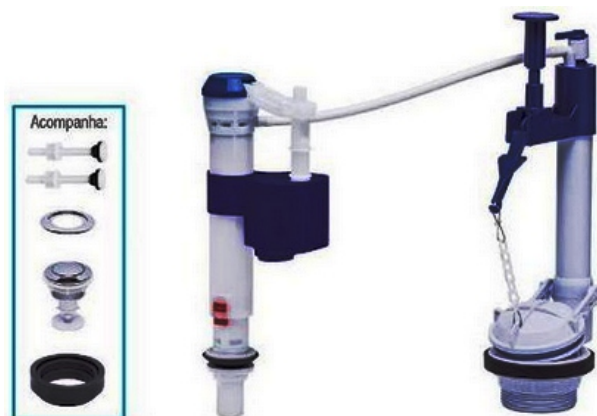

**BOLSA ESPUDE
FLEX Bs5**

CÓD. DESCRIÇÃO EMBAL.
14414 1.1/2"X40mm -----



**CONJUNTO FIXAÇÃO
PLASTICO**

CÓD. DESCRIÇÃO EMBAL.
14423 P/ CX ACOP. -----



**PORTA GRELHA
QUAD. BRANCA
Pg13**

CÓD. DESCRIÇÃO EMBAL.
14430 9,4X9,4CM -----

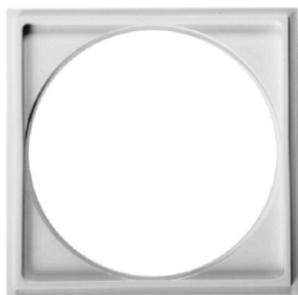

**PAPELEIRA PLAST.
PEQUENO**

CÓD. DESCRIÇÃO EMBAL.
14432 BRANCO -----



**CABIDE PLASTICO
SOBREPOR CBD1**

CÓD. DESCRIÇÃO EMBAL.
14416 BRANCO -----



**GRELHA ROTATIVA
QUAD. CROMADA
GRB12**

CÓD. DESCRIÇÃO EMBAL.
14422 9,4X9,4CM -----

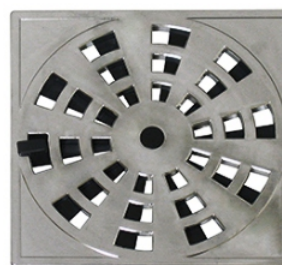

**PORTA GRELHA
QUAD. CINZA
Pg14**

CÓD. DESCRIÇÃO EMBAL.
14431 9,4X9,4CM -----

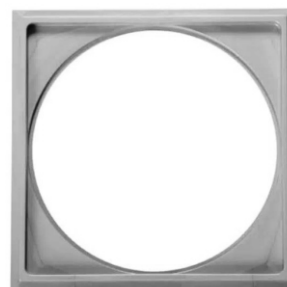

**SABONETEIRA PLAST.
PEQUENO**

CÓD. DESCRIÇÃO EMBAL.
14433 BRANCO -----



**CORRENTE
CADEADA "S"**

CÓD. DESCRIÇÃO EMBAL.
10880 C/ FIXADOR C/ 36



**OBTURADOR S/
CORRENTE P/
SAIDA D'AGUA KS/O**

CÓD. DESCRIÇÃO EMBAL.
14424 PRETO C/ 12



**OBTURADOR UNIV.
C/ CORRENTE P/
VALVULA SAIDA
D'AGUA KS/OU**

CÓD. DESCRIÇÃO EMBAL.
14425 BR / AZUL C/ 12



**BOTÃO P/ TAMPA
CX. DESCARGA
ACOPLADA MB**

CÓD. DESCRIÇÃO EMBAL.
14426 CROMADA C/ 08



**BOTÃO DUPLO P/
TAMPA CX. DESCARGA
MBD**

CÓD. DESCRIÇÃO EMBAL.
14427 CROMADA C/10



**SAIDA D'AGUA
SIMPLES**

CÓD. DESCRIÇÃO EMBAL.
14428 243MM E 90MM C/ 06



**MECANISMO COMPLETO
UNIV. C/ HEU2 SUPERIOR**

CÓD. DESCRIÇÃO EMBAL.
14429 SUPERIOR C/ 03



**TORNEIRA BOIA
1/2" e 3/4"**

CÓD. DESCRIÇÃO EMBAL.
14434 ALTA VAZÃO ----



**KIT FIXAÇÃO PARAF.
PORCA E SUPORTE
TPK PFS**

CÓD. DESCRIÇÃO EMBAL.
14435 ---- CX C/10

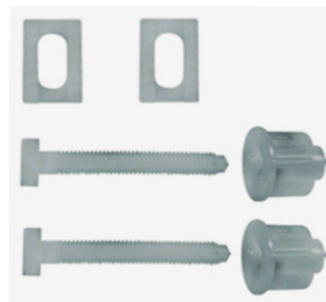



**DUCHA HIGIENICA
CR. 3287**



CÓD. DESCRIÇÃO EMBAL.
11541 ALAVANCA ----

**DUCHA HIGIENICA
PP CR. 4028**



CÓD. DESCRIÇÃO EMBAL.
11545 ECO ----

**GATILHO P/ DUCHA
CR. 3036**



CÓD. DESCRIÇÃO EMBAL.
11539 METAL ----

**GATILHO P/ DUCHA
ABS 3037**



CÓD. DESCRIÇÃO EMBAL.
11540 CROMADA ----

**GATILHO P/ DUCHA
PP BRANCO 4021**



CÓD. DESCRIÇÃO EMBAL.
11544 ECO ----

**MANGUEIRA P/
DUCHA BRANCA
3533**



CÓD. DESCRIÇÃO EMBAL.
11543 0,95 cm ----

**MANGUEIRA P/
DUCHA METAL
CR. 3035**



CÓD. DESCRIÇÃO EMBAL.
11538 1,20 cm ----

**REGISTRO P/ MAQ.
ABS BRANCO 4029**



CÓD. DESCRIÇÃO EMBAL.
11546 1/2X1/2 ----

**REGISTRO DUCHA
METAL 3531**



CÓD. DESCRIÇÃO EMBAL.
11542 1/2X1/2 ----

**REGISTRO P/ MAQ.
PP BRANCO ECO
4039**



CÓD. DESCRIÇÃO EMBAL.
11547 1/2X1/2 ----

**GATILHO PP P/
DUCHA BRANCO E
CROMADO 4881**



CÓD. DESCRIÇÃO EMBAL.
13033 ECO ----



R. São José, 508 - Centro - Areial-PB
(83) 3368-1121
ajalesatmc@hotmail.com



LINHA: BRANCA

**TORNEIRA ABS
LAVATORIO C50
REF.2772**

CÓD. DESCRIÇÃO EMBAL.
9941 GIRATÓRIA ----



**TORNEIRA ABS
ALAVANCA
REF: 2762**

CÓD. DESCRIÇÃO EMBAL.
9934 GIRATÓRIA ----



**TORNEIRA ABS
LAVAT. ALAVANCA
REF.2771**

CÓD. DESCRIÇÃO EMBAL.
9940 GIRATÓRIA ----



**TORNEIRA ABS
LAVAT. ALAVANCA
REF.2774**

CÓD. DESCRIÇÃO EMBAL.
9943 GIRATÓRIA ----



**TORNEIRA ABS
18CM ALAVANCA
REF.2778**

CÓD. DESCRIÇÃO EMBAL.
9947 P/ PIA ----



**TORNEIRA ABS
18CM ALAVANCA
C-40 REF.2998**

CÓD. DESCRIÇÃO EMBAL.
9968 P/ PIA ----



**TORNEIRA ABS
18CM ALAVANCA
C-50 REF.2779**

CÓD. DESCRIÇÃO EMBAL.
9948 P/ PIA ----



**TORNEIRA ABS
18CM ALAVANCA
CRUZ REF.2780**

CÓD. DESCRIÇÃO EMBAL.
9949 P/ PIA ----



R. São José, 508 - Centro - Areial-PB
(83) 3368-1121
ajalesatmc@hotmail.com



**TORNEIRA ABS
C-40 REF.3002**

CÓD. DESCRIÇÃO EMBAL.
9971 GIRATÓRIA ----



**TORNEIRA ABS
C-50 REF.2763**

CÓD. DESCRIÇÃO EMBAL.
9935 GIRATÓRIA ----



**TORNEIRA ABS
LAVATÓRIO
C-40 REF.3001**

CÓD. DESCRIÇÃO EMBAL.
9970 GIRATÓRIO ----



**TORNEIRA ABS
LAVATÓRIO
CRUZ REF.2773**

CÓD. DESCRIÇÃO EMBAL.
9942 GIRATÓRIO ----



**TORNEIRA ABS
MESA GIRATÓRIA**

CÓD. DESCRIÇÃO EMBAL.
9937 ALAVANCA ----
9936 CRUZ ----



REF.2765



REF.2764

**TORNEIRA ABS
MESA ALAVANCA
REF.3003**

CÓD. DESCRIÇÃO EMBAL.
9972 GIRATÓRIO ----



R. São José, 508 - Centro - Areial-PB
(83) 3368-1121
ajalesatmc@hotmail.com



LINHA: BRANCA

**TORNEIRA ABS
MESA C50
REF.2766**

CÓD. DESCRIÇÃO EMBAL.
9938 GIRATÓRIA ----



**TORNEIRA ABS
MESA CRUZ
REF: 2767**

CÓD. DESCRIÇÃO EMBAL.
9939 GIRATÓRIA ----



**TORNEIRA ABS
LAVATÓRIO**

CÓD. DESCRIÇÃO EMBAL.
9944 C-50 ----
9945 CRUZ ----



REF.9945



REF.2775

**TORNEIRA ABS
MONO COMANDO
REF.2777**

CÓD. DESCRIÇÃO EMBAL.
9946 LAVATÓRIO ----



**TORNEIRA ABS
C-40 REF.2991**

CÓD. DESCRIÇÃO EMBAL.
9962 LAVATÓRIO ----



**TORNEIRA ABS
BRANCA REF.2988**

CÓD. DESCRIÇÃO EMBAL.
9959 P/ MAQUINA
DE LAVAR ----



**TORNEIRA ABS
ALAVANCA
REF.2985**

CÓD. DESCRIÇÃO EMBAL.
9956 P/ MAQUINA
DE LAVAR ----



**TORNEIRA ABS
C-50 REF.2986**

CÓD. DESCRIÇÃO EMBAL.
9957 P/ MAQUINA
DE LAVAR ----



R. São José, 508 - Centro - Areial-PB
(83) 3368-1121
ajalesatmc@hotmail.com



**TORNEIRA ABS
REF.2987**

CÓD. DESCRIÇÃO EMBAL.
9958 P/ MAQUINA
DE LAVAR ----



**TORNEIRA ABS
ALAVANCA REF.2781**

CÓD. DESCRIÇÃO EMBAL.
9950 TANQUE ----



**TORNEIRA ABS
C-40 REF.3000**

CÓD. DESCRIÇÃO EMBAL.
9969 TANQUE ----



**TORNEIRA ABS
TANQUE**

CÓD. DESCRIÇÃO EMBAL.
9952 CRUZ ----
9951 C-50 ----



REF.2782

**DUCHA ECO
REF.3358**

CÓD. DESCRIÇÃO EMBAL.
9973 HIGIENICA ----



REF.2783

**TORNEIRA GIRAT.
C/ FILTRO PP ECO**

CÓD. DESCRIÇÃO EMBAL.
14960 BRANCO ----



**REFIL PURIFICADOR
BL**

CÓD. DESCRIÇÃO EMBAL.
14961 UNIVERSAL ----



R. São José, 508 - Centro - Areial-PB
(83) 3368-1121
ajalesatmc@hotmail.com

**TORNEIRA ABS
MESA C-40 REF.2995**

CÓD. DESCRIÇÃO EMBAL.
9966 GIRATÓRIA ----



**TORNEIRA ABS
18CM ALAVANCA
REF: 1659**

CÓD. DESCRIÇÃO EMBAL.
9927 P/ PIA ----



**TORNEIRA ABS
C-40 REF.2990**

CÓD. DESCRIÇÃO EMBAL.
9961 P/ PIA ----



**TORNEIRA ABS
18CM CRUZ
REF.1660**

CÓD. DESCRIÇÃO EMBAL.
9928 P/ PIA ----



**TORNEIRA ABS
BAIXA ALAVANCA
REF.1650**

CÓD. DESCRIÇÃO EMBAL.
9919 GIRATÓRIA ----



**TORNEIRA ABS
ALAVANCA REF.1644**

CÓD. DESCRIÇÃO EMBAL.
9913 GIRATÓRIA ----



**TORNEIRA ABS
BAIXA CRUZ
C-50 REF.1652**

CÓD. DESCRIÇÃO EMBAL.
9921 GIRATÓRIA ----



**TORNEIRA ABS
BAIXA ALAVANCA
GIRATÓRIA**

CÓD. DESCRIÇÃO EMBAL.
9967 C-40 ----
9920 C-50 ----



C-40 REF.2996

C-50 REF.1651



**TORNEIRA ABS
LAVATÓRIO CRUZ
REF.1655**

CÓD.	DESCRIÇÃO	EMBAL.
9924	GIRATÓRIA	----



**TORNEIRA ABS
C-40 REF.2994**

CÓD.	DESCRIÇÃO	EMBAL.
9965	GIRATÓRIA	----



**TORNEIRA ABS
GIRATÓRIA**

CÓD.	DESCRIÇÃO	EMBAL.
9914	C-50	----
9915	C-40	----



C-50 REF.1645



C-40 REF.1646

**TORNEIRA ABS
LAV. ALAVANCA
REF.1653**

CÓD.	DESCRIÇÃO	EMBAL.
9922	GIRATÓRIA	----



**TORNEIRA ABS
LAVATÓRIO C-40
REF.2993**

CÓD.	DESCRIÇÃO	EMBAL.
9964	GIRATÓRIA	----



**TORNEIRA ABS
LAVATÓRIO C-50
REF.1654**

CÓD.	DESCRIÇÃO	EMBAL.
9923	GIRATÓRIA	----



R. São José, 508 - Centro - Areial-PB
(83) 3368-1121
ajalesatmc@hotmail.com

**TORNEIRA ABS
MESA ALAVANCA
REF.1647**

CÓD. DESCRIÇÃO EMBAL.
9916 GIRATÓRIO ----



**TORNEIRA ABS
MESA GIRATÓRIA**

CÓD. DESCRIÇÃO EMBAL.
9917 C-50 ----
9918 CRUZ ----



REF.1648



REF.1649

**TORNEIRA ABS
ALAVANCA
REF.1667**

CÓD. DESCRIÇÃO EMBAL.
9930 LAVATÓRIO ----



**TORNEIRA ABS
MONO COMANDO
REF.1658**

CÓD. DESCRIÇÃO EMBAL.
9926 LAVATÓRIO ----



**TORNEIRA ABS
LAVATÓRIO**

CÓD. DESCRIÇÃO EMBAL.
9925 CRUZ ----
9960 C-40 ----



REF.1657



REF.2889

**TORNEIRA ABS
ALAVANCA
REF.2981**

CÓD. DESCRIÇÃO EMBAL.
9953 MAQUINA DE LAVAR ----



**TORNEIRA ABS
ALAVANCA REF.1665**

CÓD. DESCRIÇÃO EMBAL.
9929 TANQUE ----



**TORNEIRA ABS
18CM C-50 REF.1672**

CÓD. DESCRIÇÃO EMBAL.
9931 P/PIA ----





**TORNEIRA ABS
MAQUINA DE LAVAR**

CÓD.	DESCRIÇÃO	EMBAL.
9955	C-40	----
9954	CRUZ	----



REF.2984



REF.2983

**TORNEIRA ABS
LAVATÓRIO C-40
REF.2992**

CÓD.	DESCRIÇÃO	EMBAL.
9963	TANQUE	----



**TORNEIRA ABS
C-50 REF.1674**

CÓD.	DESCRIÇÃO	EMBAL.
9932	TANQUE	----



**TORNEIRA ABS
CRUZ REF.1675**

CÓD.	DESCRIÇÃO	EMBAL.
9933	TANQUE	----



**DUCHA HIGIENICA
METAL**

CÓD.	DESCRIÇÃO	EMBAL.
11163	CROMADO	----



NAPOLIS



R. São José, 508 - Centro - Areial-PB
(83) 3368-1121
ajalesatmc@hotmail.com

VALVULA AMERIC.

CÓD. DESCRIÇÃO EMBAL.
10977 BRANCA C/ 12



**VALVULA LAVAT.
S/ UNHO S/ LADRAO**

CÓD. DESCRIÇÃO EMBAL.
10956 BRANCA C/ 12



**VALVULA LAVAT.
S/ UNHO S/ LADRAO**

CÓD. DESCRIÇÃO EMBAL.
10963 CROMADA C/ 12



**VEDANTE P/
TORNEIRA**

CÓD. DESCRIÇÃO EMBAL.
10975 1/2" C/100
10976 3/4" C/100



**ADAPTADOR
VALVULA DE PIA E
LAVATÓRIO**

CÓD. DESCRIÇÃO EMBAL.
10957 7/8"x1.1/2" C/50



**BICO P/ TORNEIRA
JARDIM**

CÓD. DESCRIÇÃO EMBAL.
10937 PRETO ----



**CX. SIFONADA
QUAD. CROMADA**

CÓD. DESCRIÇÃO EMBAL.
10984 100x50x40 ----



**CX. SIFONADA
QUAD. BRANCA**

CÓD. DESCRIÇÃO EMBAL.
10983 100x50x40 ----



**RALO POPULAR
BRANCO 100mm**

CÓD. DESCRIÇÃO EMBAL.
10972 REDONDO C/25



**RALO SIFONADO
BRANCO 100mm**

CÓD. DESCRIÇÃO EMBAL.
10973 QUADRADO C/25



**ROLETE P/ PORTA
PAPEL HIGIENICO**

CÓD. DESCRIÇÃO EMBAL.
10936 BRANCO C/12



**SIFAO COPINHO
PIA AMERICANA**

CÓD. DESCRIÇÃO EMBAL.
10971 1.1/2" x 1.1/2" ----



**SIFÃO COPO P/ PIA
E LAVATÓRIO**

CÓD. DESCRIÇÃO EMBAL.
10970 S/ VALVULA ----



**SIFÃO COPO
INTELIGENTE**

CÓD. DESCRIÇÃO EMBAL.
10947 UNIVERSAL ----



**SIFAO EXTENSIVO
PORCA PLASTICO**

CÓD. DESCRIÇÃO EMBAL.
10982 ---- C/12



**SIFÃO INTELIG.
PORCA PLASTICO**

CÓD. DESCRIÇÃO EMBAL.
10944 DUPLO ----



ENGATE BRANCO

CÓD.	DESCRIÇÃO	EMBAL.
10962	1,00 mt	----
10951	1,20 mt	----



**ENGATE BRANCO
C/ GRAVAÇÃO**

CÓD.	DESCRIÇÃO	EMBAL.
10959	40 cm	C/ 20
10960	50 cm	C/ 20
19961	60 cm	C/ 20



**GRELHA REDONDA
100mm**

CÓD.	DESCRIÇÃO	EMBAL.
10939	BRANCO	C/10

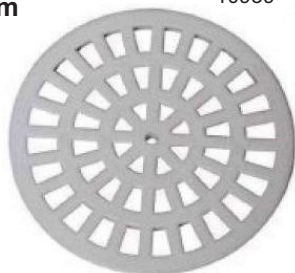

**GRELHA REDONDA
100mm**

CÓD.	DESCRIÇÃO	EMBAL.
10974	CROMADA	C/10



**KIT REPOSIÇÃO
P/ REGISTRO**

CÓD.	DESCRIÇÃO	EMBAL.
10953	REPARO	C/12



LUVA BRANCA

CÓD.	DESCRIÇÃO	EMBAL.
10938	1/2"	----



LUVA CROMADA

CÓD.	DESCRIÇÃO	EMBAL.
10980	1/2"	----



NIPEL DUPLO PP

CÓD.	DESCRIÇÃO	EMBAL.
10935	1/2" X 1/2"	----

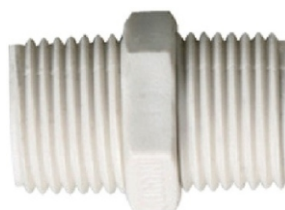

**BUCHA REDUÇÃO
ROSCA INT./EXT.**

CÓD.	DESCRIÇÃO	EMBAL.
14309	REDONDO	----



**PORTA GRELHA
QUADRADO 100mm**

CÓD.	DESCRIÇÃO	EMBAL.
10941	BRANCA	C/12
14313	CROMADO	C/12

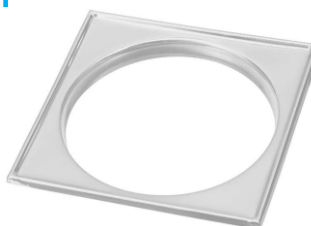

BRANCO



CROMADO

**SIFÃO INTELIGENTE
PORCA PLASTICA**

CÓD. DESCRIÇÃO EMBAL.
10981 TRIPLO -----



TANQUE BRANCO

CÓD. DESCRIÇÃO EMBAL.
10949 15 LT -----



**TORNEIRA C/
CHUVEIRO**

CÓD. DESCRIÇÃO EMBAL.
10945 1/2" C/12



**TORNEIRA JARDIM
1/2"**

CÓD. DESCRIÇÃO EMBAL.
10943 PRETO C/12



**TORNEIRA DE
LAVATÓRIO**

CÓD. DESCRIÇÃO EMBAL.
10952 1/2" C/12



**TORNEIRA
COZINHA ALAVANCA**

CÓD. DESCRIÇÃO EMBAL.
14311 1/2" C/06



**TORNEIRA
ALAVANCA CR.**

CÓD. DESCRIÇÃO EMBAL.
10954 1/2" x 3/4" C/06



TORNEIRA FILTRO

CÓD. DESCRIÇÃO EMBAL.
10950 BRANCA C/12



**PORTA GRELHA
REDONDO 100mm**

CÓD. DESCRIÇÃO EMBAL.
14310 BRANCA C/12
14312 CROMADO C/12



BRANCO

CROMADO

CESTINHA DA VALVULA AMERICANA

CÓD. DESCRIÇÃO EMBAL.
10958 CROMADO C/25



TONEIRA BOIA P/ CX. D'AGUA

CÓD. DESCRIÇÃO EMBAL.
10948 UNIVERSAL ----



UNIAO (CONEXAO) C/ PORCA BRANCA

CÓD. DESCRIÇÃO EMBAL.
10964 1/2" C/100
10967 1/2"x3/4" C/100



UNIAO (CONEXAO) C/ PORCA CROMADO

CÓD. DESCRIÇÃO EMBAL.
10965 1/2" C/100
10968 1/2"x3/4" C/100



TAMPÃO P/ VALVULA PIA E LAVATORIO

CÓD. DESCRIÇÃO EMBAL.
14308 1" C/100



TORNEIRA BOIA C/ BALAO TUB. HASTE ALUMINIO

CÓD. DESCRIÇÃO EMBAL.
10955 1/2" C/12



TORNEIRA DE PIA

CÓD. DESCRIÇÃO EMBAL.
10942 1/2" ----



UNIAO (CONEXAO) C/ PORCA BRONZE

CÓD. DESCRIÇÃO EMBAL.
10966 1/2" C/100
10969 1/2"x3/4" C/100



UNIAO (CONEXAO) C/ PORCA REFOR.

CÓD. DESCRIÇÃO EMBAL.
10978 1/2"x3/4" C/100



UNIAO (CONEXAO) CURVA C/ PORCA

CÓD. DESCRIÇÃO EMBAL.
10979 3/4" C/100





CHUVEIRO BR PEQUENO C/ BRAÇO S/ REGISTRO

CÓD.	DESCRIÇÃO	EMBAL.
15220	4"	C/12



CHUVEIRO BR PEQUENO C/ BRAÇO LONGO C/ REGISTRO

CÓD.	DESCRIÇÃO	EMBAL.
15228	4"	C/12



BRAÇO BR P/ CHUVEIRO C/ CANOPLA

CÓD.	DESCRIÇÃO	EMBAL.
15221	30CM	C/12



CRIVO P/ CHUVEIRO BRANCO

CÓD.	DESCRIÇÃO	EMBAL.
15218	4"	C/50



ASSENTO SANIT. ALMOFADADO

CÓD.	DESCRIÇÃO	EMBAL.
11471	BRANCO	C/ 06
12439	CZ. CLARO	C/ 06
12907	CARAMELO	C/ 06



- Branco
- Caramelo
- Cinza-claro

ASSENTO SANIT. COMUM

CÓD.	DESCRIÇÃO	EMBAL.
11461	BRANCO	C/ 05
11462	CARAMELO	C/ 05
11466	CZ. CLARO	C/ 05



- Branco
- Caramelo
- Cinza-claro

ASSENTO SANIT. HIGIENIC

CÓD.	DESCRIÇÃO	EMBAL.
12921	BRANCO	C/ 05
12922	CARAMELO	C/ 05
12981	CZ. CLARO	C/ 05



- Branco
- Caramelo
- Cinza-claro

TUBO DE DESCARGA

CÓD.	DESCRIÇÃO	EMBAL.
4889	----	C/ 10



KIT BÓIA

CÓD.	DESCRIÇÃO	EMBAL.
4887	----	C/ 10



CX. DESCARGA MARFIM

CÓD.	DESCRIÇÃO	EMBAL.
4881	BRANCO	C/ 05
4885	MARFIM	C/ 05
12906	CARAMELO	C/ 05



SPUDE P/ VASO SANIT.

CÓD.	DESCRIÇÃO	EMBAL.
5187	----	C/ 24



SUPORTE PVC P/ BICA

CÓD.	DESCRIÇÃO	EMBAL.
11469	BRANCO	----



BICA CALHA PVC

CÓD.	DESCRIÇÃO	EMBAL.
11463	2 MT	----
11464	3 MT	----



EMENDA PVC P/ BICA

CÓD.	DESCRIÇÃO	EMBAL.
11470	BRANCA	----



DESCIDA PVC DE ÁGUA

CÓD.	DESCRIÇÃO	EMBAL.
11465	P/ BICA	----



TAMPA PVC BR.

CÓD.	DESCRIÇÃO	EMBAL.
11467	ESQUERDA	----
11468	DIREIRA	----



TELHA TRANSL. P/177

CÓD.	DESCRIÇÃO	EMBAL.
4886	2 ONDAS	C/ 20





MOTOBOMBA FSG-S (CENTRIFUGA) VD

CÓD.	DESCRIÇÃO	EMBAL.
11756	1,5CV	----
11757	2,0CV	----
11758	3,0CV	----



MOTOBOMBA FSP-60 (PERIFERICA) VD

CÓD.	DESCRIÇÃO	EMBAL.
11760	1/2 CV	----
11759	1,0 CV	----



ASSENTO SANIT. PRIME

CÓD.	DESCRIÇÃO	EMBAL.
11434	BRANCO	C/ 10
11435	CINZA	C/ 10
11436	CARAMELO	C/ 10



PORTA SHAMPOO

CÓD.	DESCRIÇÃO	EMBAL.
11922	BRANCO	C/ 06
11923	PRETO	C/ 06
11924	CARAMELO	C/ 06



LAVATORIO COM VALVULA

CÓD.	DESCRIÇÃO	EMBAL.
11927	PRETO	----



ENGATE FLEX TRANÇADO INOX 1/2"

CÓD.	DESCRIÇÃO	EMBAL.
10215	40 CM	----
10216	60 CM	----

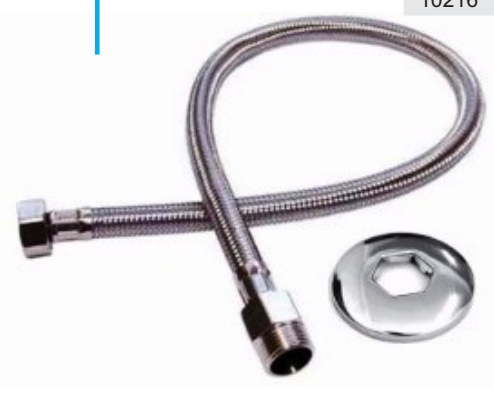

BOMBA D'GUA PERIFERICA 220V

CÓD.	DESCRIÇÃO	EMBAL.
11918	1/2 CV	----
12029	1 CV	----



MANGUEIRA CRISTAL 5/16

CÓD.	DESCRIÇÃO	EMBAL.
12454	1,2MM	C/ 50MT
12435	1,5MM	C/50MT



MANGUEIRA JARDIM LISA VERDE C/KIT

CÓD.	DESCRIÇÃO	EMBAL.
12438	10M	----
12451	15M	----
12452	20M	----



MANGUEIRA JARDIM TANÇADA VERDE C/ KIT

CÓD.	DESCRIÇÃO	EMBAL.
12436	10M	----
12437	15M	----
12453	20M	----



POLYFITA

FITA VEDA ROSCA

CÓD.	DESCRIÇÃO	EMBAL.
12265	12MMX5MT	C/120
12266	12MMX10MT	C/120
12267	18MMX05MT	C/120
12268	18MMX10MT	C/120





COLAR TOMADA PVC C/ TRAVAS

CÓD.	DESCRIÇÃO	EMBAL.
13071	60MM X 1/2"	C/50
13072	60MM X 3/4"	C/20



ABRAÇADEIRA FECHADA CONDTOP

CÓD.	DESCRIÇÃO	EMBAL.
13081	3/4"	C/50
13082	1"	C/20



JOELHO 90° GRAUS ESGOTO

CÓD.	DESCRIÇÃO	EMBAL.
12871	50 MM	SC C/30
12872	100 MM	SC C/25



CAIXA D'AGUA

CÓD.	DESCRIÇÃO	EMBAL.
8202	500 LT	----
7900	1000 LT	----



CAIXA DESCARGA S/ ENGATE

CÓD.	DESCRIÇÃO	EMBAL.
10990	BRANCO	C/ 04
8710	CINZA	C/ 04
8708	CARAMELO	C/ 04
11452	BEGE	C/ 04



KIT CX. DESCARGA BRANCA

CÓD.	DESCRIÇÃO	EMBAL.
12350	CX. + TUBO + SPUDE + ENGATE	----



R. São José, 508 - Centro - Areial-PB
 (83) 3368-1121
 ajalesatmc@hotmail.com

TUBO ESGOTO PRIM. 6mt

CÓD.	DESCRIÇÃO	EMBAL.
8690	40 mm	----
8687	50 mm	----
8688	75 mm	----
8689	100 mm	----



TUBO SOLDÁVEL 6mt

CÓD.	DESCRIÇÃO	EMBAL.
8684	20 mm	----
8685	25 mm	----
8686	50 mm	----



TORNEIRA TANQUE C/ BICO MANG. CROSS BRANCO 1/2"-3/4"

CÓD.	DESCRIÇÃO	EMBAL.
12873	10 CM	----
12874	15 CM	----



TORNEIRA TANQUE MANG. CROSS C/ BICO 1/2"-3/4" BR/CR

CÓD.	DESCRIÇÃO	EMBAL.
13074	15 CM	----



TORNEIRA COZINHA MESA ALTA BICA MOVEL ORBE 1/2"

CÓD.	DESCRIÇÃO	EMBAL.
12877	BRANCO	----

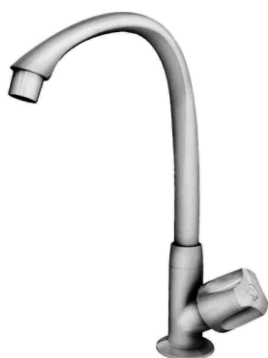

TORNEIRA COZINHA MESA ALTA BICA MOVEL CROSS 1/2"

CÓD.	DESCRIÇÃO	EMBAL.
12878	BRANCO	----

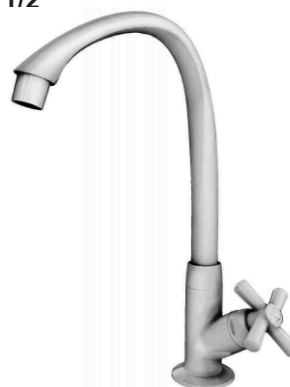

TORNEIRA COZINHA MESA ALTA MOVEL CROSS 1/2"

CÓD.	DESCRIÇÃO	EMBAL.
14171	BR/CR	----





**TORNEIRA COZINHA
MESA ALTA BICA
MOVEL ORBE 1/2"**

CÓD. DESCRIÇÃO EMBAL.
14170 BR/CR ----



**TORNEIRA COZINHA
PAREDE ALTA BICA
MOVEL 1/2"- 3/4"
CROSS**

CÓD. DESCRIÇÃO EMBAL.
12920 BRANCO ----



**TORNEIRA COZINHA
PAREDE ALTA BICA
MOVEL 1/2"-3/4"
ORBE**

CÓD. DESCRIÇÃO EMBAL.
12879 BRANCO ----



**TORNEIRA COZINHA
PAREDE ALTA 1/2"-3/4"
CROSS**

CÓD. DESCRIÇÃO EMBAL.
13075 BR/CR ----



**TORNEIRA COZINHA
PAREDE ALTA BICA
MOVEL 1/2"-3/4"
CROSS**

CÓD. DESCRIÇÃO EMBAL.
12959 PR/CR ----



**TORNEIRA COZINHA
PAREDE ALTA 1/2"-3/4"
CROSS**

CÓD. DESCRIÇÃO EMBAL.
13087 VM/CR ----



R. São José, 508 - Centro - Areial-PB
(83) 3368-1121
ajalesatmc@hotmail.com

**TORNEIRA COZINHA
PAREDE ALTA ORBE
1/2"-3/4"**

CÓD. DESCRIÇÃO EMBAL.
14172 BR/CR ----



**TORNEIRA LAVATORIO
MESA ALTA BICA
MOVEL CROSS
1/2"**

CÓD. DESCRIÇÃO EMBAL.
12882 BRANCO ----

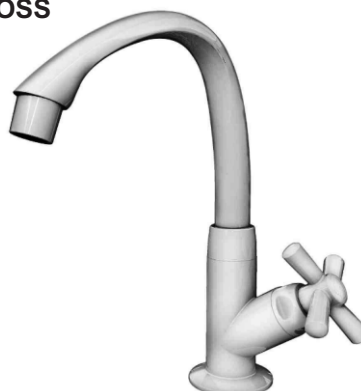

**TORNEIRA LAVATORIO
MESA ALTA BICA
MOVEL ORBE 1/2"**

CÓD. DESCRIÇÃO EMBAL.
12881 BRANCO ----



**TORNEIRA LAVATORIO
MESA ALTA BICA
MOVEL CROSS 1/2"**

CÓD. DESCRIÇÃO EMBAL.
12960 PR/CR ----



**TORNEIRA LAVATORIO
MESA ALTA BICA
MOVEL CROSS 1/2"**

CÓD. DESCRIÇÃO EMBAL.
13069 VM/CR ----



**TORNEIRA LAVATORIO
MESA CROSS 1/2"**

CÓD. DESCRIÇÃO EMBAL.
13068 BRANCO ----





**TORNEIRA LAVATORIO
MESA ORBE 1/2"**

CÓD. DESCRIÇÃO EMBAL.
12880 BRANCO ----



**TORNEIRA LAVATORIO
MESA ORBE 1/2"**

CÓD. DESCRIÇÃO EMBAL.
13076 BC/CR ----



**TORNEIRA P/
TANQUE/MAQ.
CROSS 1/2"-3/4"**

CÓD. DESCRIÇÃO EMBAL.
12883 BRANCO ----



**TORNEIRA PAREDE
MULTIUSO 1/2"-3/4"
CROSS**

CÓD. DESCRIÇÃO EMBAL.
12876 BRANCO ----



**TORNEIRA PIA
15CM 1/2"-3/4"
CROSS**

CÓD. DESCRIÇÃO EMBAL.
12875 BRANCO ----

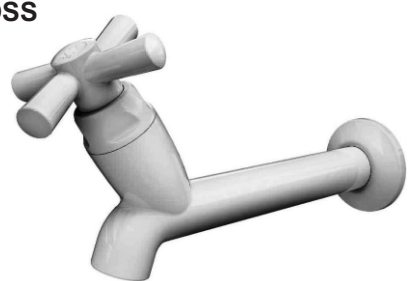

**TORNEIRA P/
TANQUE/MAQ.
CROSS 1/2"-3/4"**

CÓD. DESCRIÇÃO EMBAL.
13073 BC/CR ----



R. São José, 508 - Centro - Areial-PB
(83) 3368-1121
ajalesatmc@hotmail.com



SOLUÇÕES INTELIGENTES

**SIFÃO TUBO EXT.
PORCA PP BRANCO**

CÓD. DESCRIÇÃO EMBAL.
5459 UNIVERSAL C/25UN



**SIFÃO TUBO EXT.
BRANCO**

CÓD. DESCRIÇÃO EMBAL.
9032 DUPLO C/25UN



**TORNEIRA BR P/ MAQ.
LAVAR ABS BLISTER**

CÓD. DESCRIÇÃO EMBAL.
9033 1/4 DE VOLTA C/12UN



**ANEL VEDAÇÃO P/
VASO SANIT.**

CÓD. DESCRIÇÃO EMBAL.
9035 C/ GUIA C/24UN

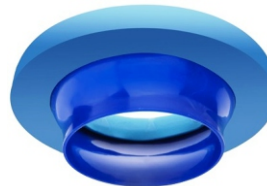

**ANEL VEDAÇÃO P/
VASO SANIT.**

CÓD. DESCRIÇÃO EMBAL.
9034 S/ GUIA C/24UN



**MECAN. ENTR. UNIV.
P/ CX. ACOPLADA**

CÓD. DESCRIÇÃO EMBAL.
9036 ALTA/BAIXA C/12UN



**MECAN. SAIDA UNIV.
P/ CX. ACOPLADA**

CÓD. DESCRIÇÃO EMBAL.
9037 ----- C/12UN



**OBTURADOR UNIV.
MECAN. SAIDA P/
CX. ACOPLADA**

CÓD. DESCRIÇÃO EMBAL.
9039 C/ CORRENTE C/12UN



**KIT COMPLETO UNIV.
P/ CX. ACOPLADA C/
MECANISMO**

CÓD. DESCRIÇÃO EMBAL.
9040 AC. SUPERIOR C/06UN



**OBTURADOR UNIV.
MECAN. SAIDA P/
CX. ACOPLADA**

CÓD. DESCRIÇÃO EMBAL.
9041 S/ CORRENTE C/12UN



R. São José, 508 - Centro - Areial-PB
(83) 3368-1121
ajalesatmc@hotmail.com



SOLUÇÕES INTELIGENTES

BORRACHA DE VEDAÇÃO UNIV.

CÓD. DESCRIÇÃO EMBAL.
14791 P/ CX. ACOPLADA C/12



BOTÃO ACIONADOR SUPERIOR UNIV. ABS P/ CX ACOPLADA

CÓD. DESCRIÇÃO EMBAL.
12812 BRANCO C/12



KIT FACIL P/ REG. PPS BLISTER

CÓD. DESCRIÇÃO EMBAL.
12808 9 EM 1 C/12



ACION. SUPERIOR P/ MECANISMO DE SAIDA MOD. ASTRA

CÓD. DESCRIÇÃO EMBAL.
12809 CX ACOPLADA C/12



PARAFUSO FIXAÇÃO P/ CX. ACOPLADA M10X80MM

CÓD. DESCRIÇÃO EMBAL.
12197 PLÁSTICO C/12UN



TORNEIRA DE BOIA

CÓD. DESCRIÇÃO EMBAL.
14790 3/4" E 1/2" C/06UN



R. São José, 508 - Centro - Areal-PB
(83) 3368-1121
ajalesatmc@hotmail.com

**JOELHO 90°
SOLD/ROSCA**

CÓD.	BITOLA	EMBAL.
3658	20X1/2	C/30UN
3655	25X1/2	C/30UN
3656	25X3/4	C/30UN

**JOELHO 90°
SOLDÁVEL**

CÓD.	BITOLA	EMBAL.
3621	20mm	C/50UN
3620	25mm	C/50UN
14215	32mm	C/25UN
14216	50mm	C/25UN
14217	60mm	C/10UN

**LUVA DE REDUÇÃO
SOLDÁVEL**

CÓD.	BITOLA	EMBAL.
3641	25X20mm	C/50UN
3637	32X25mm	C/20UN
14222	40X32MM	C/10UN
14223	50X25MM	C/10UN

**LUVA
SOLDÁVEL**

CÓD.	BITOLA	EMBAL.
3628	20mm	C/50UN
3632	25mm	C/50UN
3633	32mm	C/25UN
3634	40mm	C/10UN
14218	50mm	C/10UN
3630	85mm	C/03UN
3626	110mm	C/01UN

**TÊ 90°
SOLDÁVEL**

CÓD.	BITOLA	EMBAL.
3639	20mm	C/50UN
3642	25mm	C/50UN
3640	32mm	C/25UN
3644	40mm	C/10UN
3643	50mm	C/10UN
3645	60mm	C/05UN

**LUVA SOLDÁVEL
LISO/ROSCA**

CÓD.	BITOLA	EMBAL.
14224	20X1/2	C/50UN
3660	25X1/2	C/50UN
14225	25X3/4	C/50UN
3663	40X1.1/4	C/15UN

**JOELHO L/R
COM BUCHA
DE LATÃO**

CÓD.	BITOLA	EMBAL.
14226	20X1/2mm	C/20UN
14228	25X1/2mm	C/20UN
14227	25X3/4mm	C/20UN

**TÊ 90° REDUÇÃO
SOLDÁVEL**

CÓD.	BITOLA	EMBAL.
3646	25X20mm	C/20UN
3647	32X25mm	C/20UN
3649	40X25mm	C/10UN
3648	50X25mm	C/10UN
3650	50X32mm	C/06UN

**TE SOLDÁVEL C/
ROSCA**

CÓD.	BITOLA	EMBAL.
3665	20X1/2	C/ 20
3666	25X1/2	C/ 20
3667	25X3/4	C/ 20

**LUVA L/R
COM BUCHA
DE LATÃO**

CÓD.	BITOLA	EMBAL.
14229	20X1/2	C/20UN
14231	25X1/2	C/20UN
14230	25X3/4	C/20UN



**ADAPTADOR SOLD.
P/ CAIXA D'ÁGUA**



CÓD.	BITOLA	EMBAL.
3586	20X1/2	C/12UN
4013	25X3/4	C/12UN
4014	32X1	C/06UN
3590	40X1.1/4	C/06UN
3591	50X1.1/2	C/06UN
14197	60X2	C/06UN

**ADAPTADOR
SOLDÁVEL
CURTO**



CÓD.	BITOLA	EMBAL.
14290	20X1/2	C/50UN
14192	25X3/4	C/50UN
14193	32X1	C/25UN
14194	40X1.1/4	C/10UN
14195	50X1.1/2	C/25UN
14196	60X2	C/10UN

**BUCHA DE REDUÇÃO
SOLDÁVEL CURTO**



CÓD.	BITOLA	EMBAL.
3594	25X20mm	C/50UN
14198	32X25mm	C/50UN
14199	40X32mm	C/10UN
14200	50X40mm	C/10UN
14201	60X50mm	C/12UN

**BUCHA DE REDUÇÃO
SOLDÁVEL LONGA**



CÓD.	BITOLA	EMBAL.
14202	32X20mm	C/10UN
14203	40X20mm	C/15UN
14204	40X25mm	C/10UN
14205	50X20mm	C/10UN
14206	50X25mm	C/25UN
14207	50X32mm	C/10UN

CAP SOLDÁVEL



CÓD.	BITOLA	EMBAL.
14208	20mm	C/50UN
3612	50mm	C/10UN
3610	60mm	C/10UN

**CURVA 90°
SOLDÁVEL**



CÓD.	BITOLA	EMBAL.
14209	20mm	C/20UN
14210	25mm	C/20UN
14211	32mm	C/10UN
14212	40mm	C/10UN
3615	50mm	C/10UN

**JOELHO 45°
SOLDÁVEL**



CÓD.	BITOLA	EMBAL.
3614	20mm	C/50UN
3616	25mm	C/50UN
14213	32mm	C/10UN
14214	50mm	C/10UN



R. São José, 508 - Centro - Areial-PB
(83) 3368-1121
ajalesatmc@hotmail.com

**TÊ L/R
COM BUCHA
DE LATÃO**

CÓD.	BITOLA	EMBAL.
14232	20X1/2	C/20UN
3677	25X1/2	C/15UN
3675	25X3/4	C/20UN

**JOELHO 90° REDUÇÃO
SOLDÁVEL**

CÓD.	BITOLA	EMBAL.
3627	25X20	C/20UN

**UNIÃO
SOLDÁVEL**

CÓD.	BITOLA	EMBAL.
3651	20mm	C/20UN
3652	25mm	C/20UN
3653	32mm	C/10UN
3654	40mm	C/10UN
3657	50mm	C/10UN

**TUBO
SOLDÁVEL**

CÓD.	BITOLA	EMBAL.
6359	20mm	C/12UN
6209	25mm	C/08UN
6322	32mm	C/10UN
6323	40mm	C/05UN
6210	50mm	C/12UN
6211	60mm	C/03UN

**LUVA CORRER P/
TUBO SOLDÁVEL**

CÓD.	BITOLA	EMBAL.
14219	20MM	C/ 12
3636	25MM	C/ 12
3638	32MM	C/ 06
14220	40MM	C/ 06
14221	50MM	C/ 08

**REGISTRO DE
ESFERA SOLDÁVEL
COM UNIÃO**

CÓD.	BITOLA	EMBAL.
3676	20mm	C/10UN
3680	50mm	C/02UN

**PLUG
ROSCÁVEL**

CÓD.	BITOLA	EMBAL.
3582	1/2	C/50UN
14299	3/4	C/50UN

NIPEL ROSCAVEL

CÓD.	BITOLA	EMBAL.
14304	1/2	C/50UN
3580	3/4	C/50UN

**CURVA 90°
LONGA
ESGOTO SN**

CÓD.	BITOLA	EMBAL.
14248	40mm	C/10UN
14249	50mm	C/12UN
14250	75mm	C/10UN
14251	100mm	C/08/UN

**CURVA 90°
CURTA
ESGOTO SN**

CÓD.	BITOLA	EMBAL.
14234	40mm	C/25UN
14235	50mm	C/20UN
14236	75mm	C/10UN
14237	100mm	C/10UN



LUVA SIMPLES ESGOTO SN



CÓD.	BITOLA	EMBAL.
3697	40mm	C/25UN
3698	50mm	C/25UN
14254	75mm	C/10UN
3701	100mm	C/10UN

JOELHO 90° ESGOTO SN COM VISITA



CÓD.	BITOLA	EMBAL.
14243	100X50mm	C/10UN

JUNÇÃO SIMPLES ESGOTO SN



CÓD.	BITOLA	EMBAL.
14244	40X40mm	C/25UN
14245	50X50mm	C/10UN
14246	75X75mm	C/10UN
14247	100X100mm	C/10UN

RALO SINF. Nº37 RED. BRANCO



CÓD.	BITOLA	EMBAL.
3725	100X38X40mm	C/20UN

JOELHO 45° ESGOTO SN



CÓD.	BITOLA	EMBAL.
3684	40mm	C/25UN
3688	50mm	C/25UN
14241	75mm	C/10UN
3692	100mm	C/10UN

JOELHO 90° ESGOTO SN



CÓD.	BITOLA	EMBAL.
3691	40mm	C/50UN
3693	50mm	C/25UN
4016	75mm	C/20UN
3694	100mm	C/20UN
14242	150mm	C/05UN

JUNÇÃO DE REDUÇÃO ESGOTO SN



CÓD.	BITOLA	EMBAL.
14252	75X50mm	C/10UN
14321	100X50mm	C/10UN
14253	100X75mm	C/10UN

REDUÇÃO EXCÊNTRICA ESGOTO SN



CÓD.	BITOLA	EMBAL.
3702	100X50mm	C/10UN
14258	100X75mm	C/10UN

RALO SINF. Nº43 QUAD. BRANCO



CÓD.	BITOLA	EMBAL.
3718	100X52X40mm	C/20UN

**TÊ ESGOTO
SN**

CÓD.	BITOLA	EMBAL.
3705	40mm	C/25UN
3708	50mm	C/10UN
3706	75mm	C/10UN
3709	100mm	C/10UN
3710	150mm	C/05UN

**TÊ DE REDUÇÃO
ESGOTO SN**

CÓD.	BITOLA	EMBAL.
3711	75X50mm	C/10UN
3713	100X50mm	C/10UN
3707	100X75mm	C/10UN

**CAIXA SIFONADA
QUAD. Nº5**

CÓD.	BITOLA	EMBAL.
14270	100X100X50	C/12UN

**CAIXA SIFONADA
QUAD. Nº13 C/ GRELHA**

CÓD.	BITOLA	EMBAL.
14271	150X150X50	C/06UN

**CAIXA SIFONADA
QUAD. Nº17 C/ GRELHA**

CÓD.	BITOLA	EMBAL.
14272	150X185X75	C/06UN

**CAIXA SIFONADA
QUAD. Nº22**

CÓD.	BITOLA	EMBAL.
14273	250X230X75	C/04UN

**LUVA CORRER P/
TUBO ESG.**

CÓD.	BITOLA	EMBAL.
14255	DN 40	C/ 10
14305	DN 50	C/ 10
14256	DN 75	C/ 10
14257	DN 100	C/ 10

**CURVA 45°
ESGOTO**

CÓD.	BITOLA	EMBAL.
14238	40mm	C/10UN
14239	50mm	C/05UN
14240	100mm	C/05UN





CAP ESGOTO SN



CÓD.	BITOLA	EMBAL.
3682	40mm	C/10UN
3683	50mm	C/05UN
14233	75mm	C/10UN
3686	100mm	C/10UN
14298	150mm	C/10UN

ANEL DE VEDAÇÃO P/ ESGOTO



CÓD.	BITOLA	EMBAL.
14259	DN 40mm	C/50UN
14260	DN 50mm	C/50UN
14261	DN 75mm	C/25UN
14262	DN 100mm	C/25UN
14263	DN 150mm	C/15UN

CAP ROSCAVEL BRANCO



CÓD.	BITOLA	EMBAL.
14189	3/4"	C/30UN
14190	1"	C/15UN
14191	1.1/2"	C/10UN

ENGATE PLASTICO C/ NIPEL 1/2"



CÓD.	DESCRIÇÃO	EMBAL.
14266	40 CM	C/20UN
3704	50 CM	C/20UN
14267	60 CM	C/20UN
14268	1 MT	C/05UN

TUBO ESGOTO SN



CÓD.	BITOLA	EMBAL.
6360	40mm	----
6212	50mm	----
6213	75mm	----
6214	100mm	----
6215	150mm	----

BUCHA REDUÇÃO LONGA P/ ESGOTO



CÓD.	BITOLA	EMBAL.
3681	50X40	C/25UN

JOELHO 90° ROSC.



CÓD.	BITOLA	EMBAL.
3566	1/2"	C/20UN
3567	3/4"	C/20UN
3568	1"	C/24UN

JOELHO REDUÇÃO ROSCAVEL BRANCO



CÓD.	BITOLA	EMBAL.
3569	3/4X1/2	C/20UN

LUVA REDUÇÃO ROSCAVEL BRANCO



CÓD.	BITOLA	EMBAL.
3578	3/4X1/2	C/25UN

**TE ROSCAVEL
BRANCO**

CÓD.	BITOLA	EMBAL.
3575	1/2"	C/20UN
3574	3/4"	C/20UN
3583	1"	C/16UN

**TUBO P/ CAIXA
DESCARGA CURTO
C/ CURVA**

CÓD.	BITOLA	EMBAL.
3720	DN 40mm	C/10UN

**COLAR DE TOMADA
PVC C/ TRAVA**

CÓD.	BITOLA	EMBAL.
14286	50MM x 1/2"	C/10UN
14287	50MM x 3/4"	C/10UN
14288	60MM x 1/2"	C/10UN
14289	60MM x 3/4"	C/10UN

**VALVULA P/ LAVAT./
TANQUE**

CÓD.	DESCRIÇÃO	EMBAL.
3719	V8	C/20UN

**VALVULA P/ POÇO
C/ FILTRO**

CÓD.	BITOLA	EMBAL.
3726	3/4"	C/06UN
3728	1"	C/06UN
3729	1.1/2"	C/03UN
14274	2"	C/06UN

**TORNEIRA BOIA
P/ BEBEDOURO 1/2**

CÓD.	BITOLA	EMBAL.
14265	1/2"	C/20UN

**TORNEIRA BOIA
P/ CAIXA D'AGUA**

CÓD.	BITOLA	EMBAL.
14264	1/2"	C/20UN

**TORNEIRA ESFERA
1/2" E 3/4"**

CÓD.	DESCRIÇÃO	EMBAL.
14269	P/ JARDIM/ TANQUE	C/06UN

POLYUTIL

KIT COMPLETO DE ACIONAMENTO P/ CX. DESCARGA ACOPLADA

CÓD. DESCRIÇÃO EMBAL.
10313 5 PÇS ----



MECANISMO P/ CX. ACOPLADA

CÓD. DESCRIÇÃO EMBAL.
10415 ENTRADA ----
10416 SAIDA ----



ENTRADA



ENTRADA

BORRACHA DE VEDACAO P/ BACIA SANITARIO

CÓD. DESCRIÇÃO EMBAL.
12078 PRETO ----



BOTÃO ACIONADOR P/ CX. ACOPLADA

CÓD. DESCRIÇÃO EMBAL.
12079 BRANCO ----



CAIXA HIDRÔMETRO CAGEPA

CÓD. DESCRIÇÃO EMBAL.
5630 P/ PAREDE C/10UN

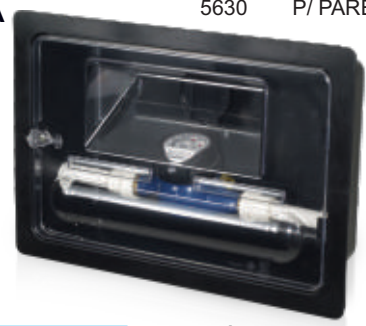

TAMPA HIDRÔMETRO CAGEPA

CÓD. DESCRIÇÃO EMBAL.
10465 Nº1 ----



CAIXA HIDRÔMETRO CAGEPA PAREDE

CÓD. DESCRIÇÃO EMBAL.
11149 S/ TAMPA C/10UN



CAIXA HIDROMETRO N6 CAGEPA

CÓD. DESCRIÇÃO EMBAL.
9294 P/ PISO C/ 05



R. São José, 508 - Centro - Areial-PB
(83) 3368-1121
ajalesatmc@hotmail.com

**BOMBA SUBMERSA
SAPO
ZINCADA
600**

CÓD.DESCRICÃO EMBAL.
4549 220V C/01UN



**BOMBA SUBMERSA
SAPO
ZINCADA
220V**

CÓD.DESCRICÃO EMBAL.
5188 650 C/01UN
4550 930 C/01UN



650



930

**BOMBA SUBMERSA
SAPO
ZINCADA
830**

CÓD.DESCRICÃO EMBAL.
5189 220V C/01UN



VEDA ROSCA

CÓD. DESCRICÃO EMBAL.
9147 5 MT C/ 01



**BOMBA PERIFERICA
220V**

CÓD.DESCRICÃO EMBAL.
5474 Bp500 1/2 HP ----
5475 Bp1000 1 HP ----



**JOELHO 90°
SOLD/ROSCA**



CÓD.	BITOLA	EMBAL.
7576	20X1/2	C/30UN
8049	25X1/2	C/20UN
8050	25X3/4	C/30UN

**JOELHO 90°
SOLDÁVEL**



CÓD.	BITOLA	EMBAL.
7574	20mm	C/50UN
7575	25mm	C/50UN
7673	32mm	C/25UN
8048	40mm	C/10UN
7674	50mm	C/20UN
7675	60mm	C/10UN

**LUVA DE REDUÇÃO
SOLDÁVEL**



CÓD.	BITOLA	EMBAL.
8069	25X20mm	C/50UN
7678	32X25mm	C/20UN

**LUVA
SOLDÁVEL**



CÓD.	BITOLA	EMBAL.
7577	20mm	C/50UN
8051	25mm	C/50UN
8052	32mm	C/25UN
8053	40mm	C/10UN
7578	50mm	C/10UN
8054	60mm	C/10UN

**TÊ 90°
SOLDÁVEL**



CÓD.	BITOLA	EMBAL.
7580	20mm	C/50UN
8057	25mm	C/50UN
7677	32mm	C/15UN
8058	40mm	C/10UN
7581	50mm	C/10UN
8059	60mm	C/05UN

**LUVA SOLDÁVEL
LISO/ROSCA**



CÓD.	BITOLA	EMBAL.
7676	20X1/2	C/25UN
8055	25X1/2	C/30UN
8056	25X3/4	C/30UN

**JOELHO L/R
COM BUCHA
DE LATÃO**



CÓD.	BITOLA	EMBAL.
7582	20X1/2mm	C/15UN
7583	25X1/2mm	C/20UN
8063	25X3/4mm	C/10UN

**TÊ 90° REDUÇÃO
SOLDÁVEL**



CÓD.	BITOLA	EMBAL.
8060	25X20mm	C/20UN
8061	32X25mm	C/20UN
11645	40X25mm	C/10UN
8062	50X25mm	C/10UN

**LUVA L/R
COM BUCHA
DE LATÃO**

CÓD.	BITOLA	EMBAL.
8064	20X1/2	C/20UN
12024	25X1/2	C/20UN
8065	25X3/4	C/20UN

**TE SOLDÁVEL C/
ROSCA**



CÓD.	BITOLA	EMBAL.
10783	20X1/2	C/ 20
10784	25X1/2	C/ 20
10785	25X3/4	C/ 20



R. São José, 508 - Centro - Areal-PB
(83) 3368-1121
ajalesatmc@hotmail.com

ADAPTADOR FLANGE P/ CAIXA D'ÁGUA SOLDÁVEL



CÓD.	BITOLA	EMBAL.
7564	20X1/2	C/12UN
7659	25X3/4	C/10UN
7565	32X1	C/6UN
7660	40X1.1/4	C/06UN
7661	50X1.1/2	C/05UN
7662	60X2	C/05UN

ADAPTADOR SOLDÁVEL CURTO



CÓD.	BITOLA	EMBAL.
7566	20X1/2	C/50UN
7663	25X3/4	C/50UN
7567	32X1	C/25UN
8042	40X1.1/4	C/10UN
7664	50X1.1/2	C/25UN
7665	60X2	C/10UN

BUCHA DE REDUÇÃO SOLDÁVEL CURTO



CÓD.	BITOLA	EMBAL.
7666	25X20mm	C/50UN
7667	32X25mm	C/50UN
7668	40X32mm	C/10UN
9847	50X40mm	C/10UN
8043	60X50mm	C/12UN

BUCHA DE REDUÇÃO SOLDÁVEL LONGA



CÓD.	BITOLA	EMBAL.
7669	40X25mm	C/10UN
8044	50X25mm	C/25UN
8045	50X32mm	C/10UN

CAP SOLDÁVEL



CÓD.	BITOLA	EMBAL.
7568	20mm	C/50UN
7670	25mm	C/50UN
7671	32mm	C/25UN
7672	40mm	C/10UN
7569	50mm	C/10UN
8046	60mm	C/10UN

CURVA 45° SOLDÁVEL



CÓD.	BITOLA	EMBAL.
8148	20mm	C/20UN
8070	32mm	C/10UN
8071	40mm	C/05UN
8072	50mm	C/05UN

JOELHO 45° SOLDÁVEL



CÓD.	BITOLA	EMBAL.
9848	20mm	C/40UN
7573	25mm	C/40UN
9849	32mm	C/10UN
9850	50mm	C/10UN

CURVA 90° SOLDÁVEL



CÓD.	BITOLA	EMBAL.
7570	20mm	C/20UN
7571	25mm	C/20UN
8047	32mm	C/10UN
7572	40mm	C/10UN
8603	50mm	C/10UN

**TÊ L/R
COM BUCHA
DE LATÃO**



CÓD.	BITOLA	EMBAL.
8066	20X1/2	C/20UN
8067	25X1/2	C/15UN
8068	25X3/4	C/15UN

**JOELHO 90° REDUÇÃO
SOLDÁVEL**



CÓD.	BITOLA	EMBAL.
9852	25X20	C/20UN

**UNIÃO
SOLDÁVEL**



CÓD.	BITOLA	EMBAL.
7679	20mm	C/20UN
7584	25mm	C/20UN
7680	32mm	C/10UN
8073	40mm	C/10UN
7681	50mm	C/10UN

**TUBO
SOLDÁVEL**



CÓD.	BITOLA	EMBAL.
7505	20mm	C/10UN
7506	25mm	C/08UN
7507	32mm	C/10UN
7508	40mm	C/07UN
7509	50mm	C/05UN
7516	60mm	C/03UN
12020	75mm	C/01UN

**LUVA CORRER P/
TUBO SOLDÁVEL**



CÓD.	BITOLA	EMBAL.
9851	20MM	C/12UN
10781	25MM	C/12UN
11235	32MM	C/12UN
11236	40MM	C/12UN
11237	50MM	C/12UN

**REGISTRO DE
ESFERA SOLDÁVEL
COM UNIÃO**



CÓD.	BITOLA	EMBAL.
8435	20mm	C/10UN
8436	25mm	C/10UN
8284	32mm	C/10UN
8437	40mm	C/10UN
8438	50mm	C/10UN
11662	60mm	C/05UN

**PLUG
ROSCÁVEL**



CÓD.	BITOLA	EMBAL.
7579	1/2	C/50UN
8458	3/4	C/50UN

NIPEL ROSCAVEL



CÓD.	BITOLA	EMBAL.
10782	1/2	C/50UN
15107	3/4"	C/50UN

**CURVA 90°
CURTA
ESGOTO SN**



CÓD.	BITOLA	EMBAL.
7684	40mm	C/25UN
7685	50mm	C/20UN
8077	75mm	C/10UN
8078	100mm	C/10UN

**CURVA 90°
LONGA
ESGOTO SN**



CÓD.	BITOLA	EMBAL.
7686	40mm	C/10UN
7687	50mm	C/12UN
8099	75mm	C/10UN
8100	100mm	C/05UN
8101	150mm	C/02UN

CURVA 45° LONGA ESGOTO SN



CÓD.	BITOLA	EMBAL.
8094	40mm	C/10UN
8095	50mm	C/05UN
8096	75mm	C/10UN
8097	100mm	C/05UN
8098	150mm	C/01UN

JOELHO 45° ESGOTO SN



CÓD.	BITOLA	EMBAL.
8079	40mm	C/25UN
7588	50mm	C/15UN
8080	75mm	C/10UN
7589	100mm	C/10UN
8081	150mm	C/01 UN

JOELHO 90° ESGOTO SN COM VISITA



CÓD.	BITOLA	EMBAL.
8102	100X50mm	C/10UN

JOELHO 90° ESGOTO SN



CÓD.	BITOLA	EMBAL.
7590	40mm	C/25UN
7591	50mm	C/25UN
7592	75mm	C/10UN
7593	100mm	C/10UN
9855	150mm	C/01UN

JUNÇÃO SIMPLES ESGOTO SN



CÓD.	BITOLA	EMBAL.
8082	40mm	C/25UN
8083	50mm	C/10UN
8084	75mm	C/10UN
8085	100mm	C/10UN
11238	150mm	C/01UN

JUNÇÃO DE REDUÇÃO ESGOTO SN



CÓD.	BITOLA	EMBAL.
8088	75X50mm	C/10UN
8086	100X50mm	C/10UN
8087	100X75mm	C/10UN

LUVA SIMPLES ESGOTO SN



CÓD.	BITOLA	EMBAL.
8089	40mm	C/20UN
8090	50mm	C/25UN
7594	75mm	C/10UN
7595	100mm	C/10UN
8091	150mm	C/05UN
11647	200mm	----

REDUÇÃO EXCÊNTRICA ESGOTO SN



CÓD.	BITOLA	EMBAL.
7598	75X50mm	C/10UN
7596	100X50mm	C/10UN
7597	100X75mm	C/10UN

RALO SECO QUAD. BRANCO



CÓD.	BITOLA	EMBAL.
11663	100X52X40mm	C/12UN

TÊ ESGOTO SN



CÓD.	BITOLA	EMBAL.
8092	40mm	C/25UN
7599	50mm	C/10UN
7600	75mm	C/10UN
7601	100mm	C/10UN
9856	150mm	C/01UN

TÊ DE REDUÇÃO ESGOTO SN



CÓD.	BITOLA	EMBAL.
8285	75X50mm	C/10UN
7602	100X50mm	C/10UN
8093	100X75mm	C/10UN
11241	150X100mm	C/01UN

TUBO ESGOTO SN



CÓD.	BITOLA	EMBAL.
7510	40mm	C/07UN
7511	50mm	C/07UN
7512	75mm	C/05UN
7513	100mm	C/05UN
7514	150mm	C/01UN

CAIXA SIFONADA QUAD. 4 ENTRADAS



CÓD.	BITOLA	EMBAL.
8074	100x100x50	C/12UN
9719	100x150x50	C/12UN
8075	150x150x50	C/06UN

CAIXA SIFONADA QUADRADA



7 ENTRADAS

CÓD.	BITOLA	EMBAL.
8439	100X100X50 7 ENTRADAS	C/06UN
15108	150X185X75 5 ENTRADAS	C/06UN



5 ENTRADAS

CAP ESGOTO SN



CÓD.	BITOLA	EMBAL.
7585	40mm	C/10UN
7683	50mm	C/10UN
7586	75mm	C/10UN
7587	100mm	C/10UN
8076	150mm	C/01UN
11646	200mm	C/01UN

REDUÇÃO EXCENT. ESG.



CÓD.	DESCRIÇÃO	EMBAL.
10789	150X100	C/01

LUVA CORRER P/ TUBO ESG.



CÓD.	DESCRIÇÃO	EMBAL.
11239	DN 40	C/ 10
10786	DN 50	C/ 10
10787	DN 75	C/ 10
11240	DN 100	C/ 10

GRELHA BRANCO



CÓD. DESCRIÇÃO EMBAL.

	100MM	
9853	QUADRADO	C/20
15109	REDONDO	C/20
	150MM	
9854	QUADRADO	C/20



**PORTA GRELHA
BRANCO 100MM**

CÓD. DESCRIÇÃO EMBAL.

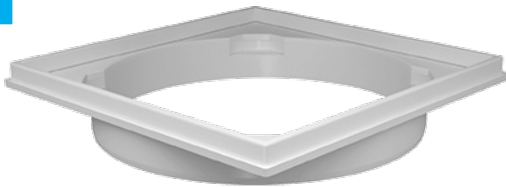
10788 QUADRADO C/12UN
9857 REDONDO C/12UN**BUCHA REDUÇÃO
LONGA ESGOTO**

CÓD. DESCRIÇÃO EMBAL.

7682 50X40MM C/20

**ANEL DE VEDAÇÃO
PARA ESGOTO**

CÓD. BITOLA EMBAL.

8103	40mm	C/50UN
8104	50mm	C/50UN
8105	75mm	C/25UN
8106	100mm	C/25UN
8107	150mm	C/15UN
8108	200mm	C/05UN

**CAIXA D'ÁGUA
DE POLIETILENO**

CÓD. DESCRIÇÃO

4263 1000 lt
4262 500 lt

**PAPELEIRA C/
PROTEÇÃO MONACO**

CÓD.DESCRICÃO EMBAL.

5465 BRANCO ----

7109 CR. CRISTAL ----



**SABONETEIRA P/
PAREDE MONACO**

CÓD.DESCRICÃO EMBAL.

5464 CROMADO ----

5466 BRANCO ----



**SIFÃO COMPACTO
BRANCO**

CÓD.DESCRICÃO EMBAL.

3779 UNIVERSAL C/10UN



**SIFÃO COMPACTO
BRANCO**

CÓD.DESCRICÃO EMBAL.

3780 DUPLO C/10UN

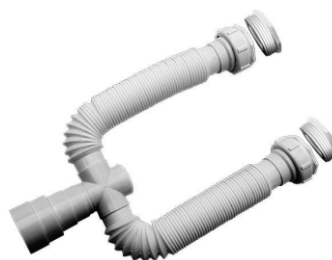

**SIFÃO COMPACTO
BRANCO**

CÓD.DESCRICÃO EMBAL.

3781 TRIPLO C/10UN

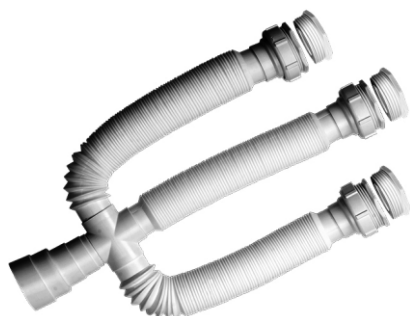

**CHUVEIRO C/ BRAÇO
S/ REGISTRO BR.**

CÓD. BITOLA EMBAL.

7108 4" ----

3795 6" ----



**KIT ACESSÓRIO
MONACO P/
BANHEIRO**

CÓD. DESCRICÃO EMBAL.

4948 SUPER CRISTAL C/05UN

4957 BRANCO C/05UN



SUPER CRISTAL



BRANCO

ARMÁRIO P/ BANHEIRO



CÓD.	DESCRIÇÃO	EMBAL.
5461	PRETO	C/05UN
3782	BRANCO	C/05UN
3783	BEGE	C/05UN
3784	CZ CLARO	C/05UN
3785	CZ ESCURO	C/05UN
3786	CARAMELO	C/05UN



ASSENTO SANIT. UNIVERSAL



CÓD.	DESCRIÇÃO	EMBAL.
3768	BRANCO	C/10UN
3769	BEGE	C/10UN
3770	CZ ESCURO	C/10UN
3771	CZ CLARO	C/10UN
3772	CARAMELO	C/10UN

ASSENTO SANIT. ESPECIAL



CÓD.	DESCRIÇÃO	EMBAL.
14550	BRANCO	C/06UN
14551	PRETO	C/06UN

ALMOFADADO

ASSENTO SANIT. UNIVERSAL



CÓD.	DESCRIÇÃO	EMBAL.
3773	BRANCO	C/10UN
3774	BEGE	C/10UN
3775	CZ CLARO	C/10UN
3776	CARAMELO	C/10UN
3777	CZ ESCURO	C/10UN
3778	PRETO	C/10UN

ALMOFADADO

FRANPLÁSTICOS

MANGUEIRA PRETA

CÓD.	BITOLA	EMBAL.
9544	1/2"X1,5MM	----
9543	3/4"X2,0MM	----
9545	1"X2,0MM	----



**BACIA SANITARIA
COVENCIONAL
SAVEIRO**

CÓD.DESCRICÃO EMBAL.

14743	BRANCO	----
14744	CINZA PRATA	----
15118	OCRE	----



Imagem ilustrativa

**CONJUNTO BACIA
C/ CAIXA P/ 3/6 LT
SAVEIRO**

CÓD.DESCRICÃO EMBAL.

14799	BRANCO	----
12783	PRETO	----
14965	CZ PRATA	----



**CONJUNTO BACIA
C/ CAIXA P/ 3/6 LT
LINHA LIKE LUXO**

CÓD.DESCRICÃO EMBAL.

12346	BRANCO	----
-------	--------	------



**LAVATÓRIO P/
COLUNA 470X385
FURO CENTRAL
S/ LADRÃO**

CÓD.DESCRICÃO EMBAL.

12781	PRETO	----
14741	BRANCO	----
14963	CZ PRATA	----

**LINHA SAVEIRO/
AZALEIA**



**COLUNA P/ LAVAT.
UP/SVEIRO**

CÓD.DESCRICÃO EMBAL.

12782	PRETO	----
14742	BRANCO	----
14964	CZ PRATA	----



BACIA CONVENCIONAL

CÓD.DESCRICÃO EMBAL.

6351	BRANCA	----
6277	BEGE AREIA	----
6276	CZ CLARO	----
6561	CZ ESCURO	----
6278	OCRE	----



CONJUNTO BACIA C/ CAIXA ACOPL. 3/6 LT

CÓD.DESCRICÃO EMBAL.

12208	CINZA	----
12210	BEGE AREIA	----
12237	BRANCO	----
1211	CZ CLARO	----
12209	OCRE	----



LAVATORIO P/ COLUNA 470X425 FURO CENTRAL S/ LADRAO PARATI

CÓD.DESCRICÃO EMBAL.

12198	BRANCO	----
12199	CINZA	----
12200	OCRE	----
12202	CINZA CLARO	----
12201	BEGE	----



COLUNA P/ LAVAT PARATI

CÓD.DESCRICÃO EMBAL.

12203	BRANCA	----
12204	CINZA	----
12205	OCRE	----
12206	BEGE AREIA	----
12207	CZ CLARO	----



LAVATÓRIO SUSPENSO 380X280 FASL COLIBRI

CÓD.DESCRICÃO EMBAL.

6348	BRANCO	----
------	--------	------



LAVATORIO SUSPENSO 465X340 FURO APONT. S/ LADRÃO GUARAPARI

CÓD.DESCRICÃO EMBAL.

6510	BRANCA	----
14315	CZ CLARO	----
14316	BEGE AREIA	----
14317	CINZA	----
14362	OCRE	----



CUBA EMB OVAL 390X300

CÓD.DESCRICÃO EMBAL.

6949	BRANCO	----
------	--------	------





Sistemas hidrossanitários

**KIT COMPLETO
P/ CAIXA ACOPLADA
CONVENCIONAL**

CÓD. DESCRIÇÃO EMBAL.
4815 P/ACIONADOR ----



**KIT P/ CX. ACOPLADA
ENTRADA POP FLUX
E SAIDA DUAL FLUSH**

CÓD. DESCRIÇÃO EMBAL.
11601 3 EM 1 ----



**KIT P/ CX. ACOPLADA
ENTRADA POP FLUX
E SAIDA CONVENCIONAL**

CÓD. DESCRIÇÃO EMBAL.
14911 BRANCO ----



**MECANISMO DE
SAIDA DUAL FLUSH
P/ CX. ACOPLADA**

CÓD. DESCRIÇÃO EMBAL.
11600 3 EM 1 ----



**MECANISMO DE SAÍDA
CONVENCIONAL P/
CAIXA ACOPLADA**

CÓD. DESCRIÇÃO EMBAL.
5966 BRANCO ----



**MECANISMO DE
ENTRADA PARA CAIXA
ACOMPLADA**

CÓD. DESCRIÇÃO EMBAL.
5964 BRANCO C/20UN



R. São José, 508 - Centro - Areial-PB
(83) 3368-1121
ajalesatmc@hotmail.com

MANGUEIRA ENGATE FLEXIVEL P/ DUCHA AÇO INOX

CÓD. 10257 DESCRIÇÃO 1,20MT EMBAL. ----



DUCHA HIGIENICA POP CROMADA C/ REGISTRO

CÓD. 14910 DESCRIÇÃO 1,20MT EMBAL. ----



ESGUICHO P/ DUCHA HIG. C/ SUPORTE

CÓD. 10258 DESCRIÇÃO BRANCA EMBAL. C/ 20

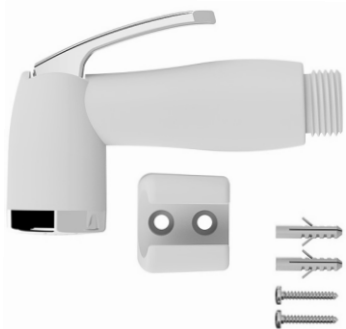

VEDANTE DE BORRACHA (OBTURADOR) DO MECANISMO DE SAÍDA

CÓD. 5969 DESCRIÇÃO C/ CORRENTE EMBAL. C/20UN



VEDANTE MEC. DE SAIDA BORRACHA SILICONE

CÓD. 10260 DESCRIÇÃO P/ CX ACOPLADA EMBAL. C/20UN



VEDANTE DE BORRACHA DO MECANISMO DE SAÍDA

CÓD. 9019 DESCRIÇÃO PVC EMBAL. C/20UN



VEDANTE DE BORRACHA (OBTURADOR) DO MECANISMO DE SAÍDA

CÓD. 5971 DESCRIÇÃO S/ CORRENTE EMBAL. C/20UN



KIT VEDAÇÃO E FIXAÇÃO

CÓD. DESCRIÇÃO EMBAL.
14913 P/ CX ACOPLADA C/10



CONJ. FIXAÇÃO POLIACETAL P/ CX. ACOPLADA

CÓD. DESCRIÇÃO EMBAL.
9020 PLASTICO -----



BOTAO ACIONADOR P/ MEC. DE CX ACOPL. SAIDA CONVENCIONAL

CÓD. DESCRIÇÃO EMBAL.
14912 C/ CORRENTE C/10



VEDANTE DE BORRACHA EXPANDIDA P/ CX. ACOPLADA

CÓD. DESCRIÇÃO EMBAL.
5967 PRETO C/20UN



BOTÃO ACIONADOR DE ABS PARA CAIXA ACOPLADA

CÓD. DESCRIÇÃO EMBAL.
5968 - C/20UN



ADAPTADOR P/ MEC. SAIDA

CÓD. DESCRIÇÃO EMBAL.
10259 CONVENCIONAL ----

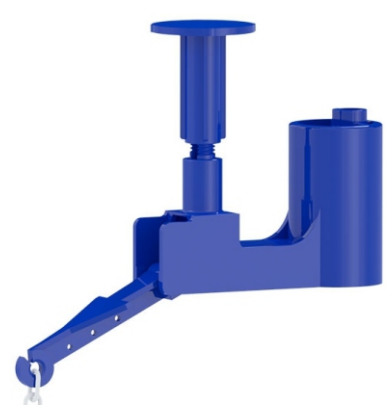

ANEL DE VEDAÇÃO PARA BACIA SANITÁRIA

CÓD. DESCRIÇÃO EMBAL.
5973 C/ GUIA C/10UN
5972 S/ GUIA C/10UN



KIT COMPLETO DE REPARO SALVA REGISTRO

CÓD. DESCRIÇÃO EMBAL.
10256 9 PÇS C/ 12

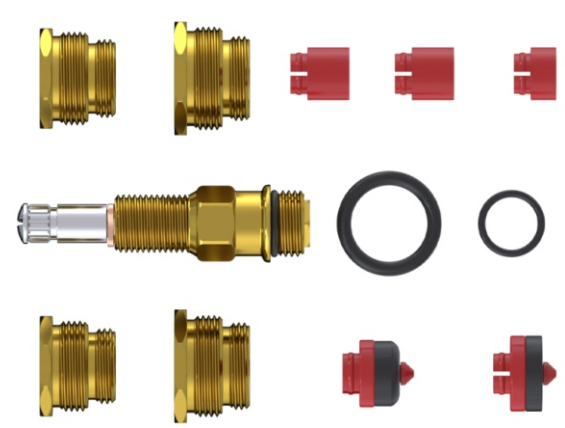



Sistemas hidrossanitários

SIFÃO UNIVERSAL POP C/ SUPORTE

CÓD.DESCRICÃO EMBAL.
10255 60 CM ----



TUBO EXT. C/ SUPORTE BRANCO UNIVERSAL

CÓD.DESCRICÃO EMBAL.
9021 74 CM ----



SIFÃO EXTENSIVO POP C/ SUPORTE

CÓD. DESCRICÃO EMBAL.
14909 REMOVIVEL ----

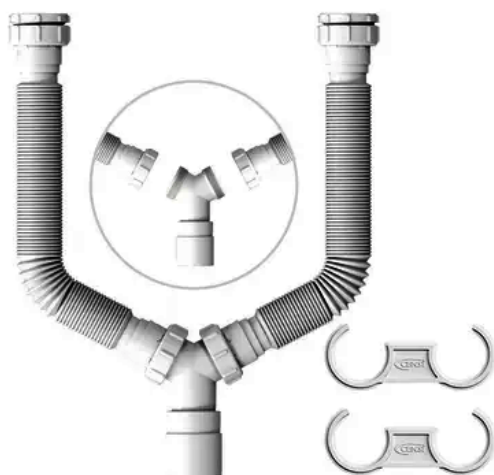

KIT ACESSORIOS SABA CROMADO P/ BANHEIRO

CÓD.DESCRICÃO EMBAL.
14990 5 PEÇAS ----



KIT FIXAÇÃO LATERAL

CÓD.DESCRICÃO EMBAL.
14989 P/ BACIAS ----



R. São José, 508 - Centro - Areial-PB
(83) 3368-1121
ajalesatmc@hotmail.com

CABIDE INOX



CÓD.	DESCRIÇÃO	EMBAL.
9454	DUPLO	----

GRELHA QUADRADO S/ CACHILHO

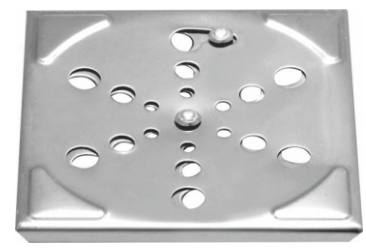

CÓD.	DESCRIÇÃO	EMBAL.
9449	10 X 10cm	-----
9450	15 X 15cm	-----

GRELHA QUADRADO C/ CACHILHO



CÓD.	DESCRIÇÃO	EMBAL.
9452	10 X 10cm	----
9451	15 X 15cm	----

GRELHA REDONDO C/ CACHILHO



CÓD.	DESCRIÇÃO	EMBAL.
9453	10 X 10cm	----

GRELHA REDONDO C/ CACHILHO



CÓD.	DESCRIÇÃO	EMBAL.
9449	10 X 10cm	----

KIT STANDER



CÓD.	DESCRIÇÃO	EMBAL.
9439	5 PÇS	----

PAPELEIRO STANDER



CÓD.	DESCRIÇÃO	EMBAL.
9455	C/ TAMPA	----

PORTA TOALHA STANDER



CÓD.	DESCRIÇÃO	EMBAL.
9456	RETO	----



R. São José, 508 - Centro - Areial-PB
 (83) 3368-1121
 ajalesatmc@hotmail.com

PORTA TOALHA STANDER



CÓD.	DESCRIÇÃO	EMBAL.
9440	ARGOLA	----

PUXADOR BARRA CHATA



CÓD.	DESCRIÇÃO	EMBAL.
9442	30 cm	----
9443	40 cm	----
9444	60 cm	----
15149	90 cm	----

PUXADOR BARRA REDONDO



CÓD.	DESCRIÇÃO	EMBAL.
9445	30 cm	----
9446	40 cm	----
9447	60 cm	----
9846	90 cm	----

SABONETEIRA STANDER



CÓD.	DESCRIÇÃO	EMBAL.
9438	INOX	----

BARRA DE APOIO



CÓD.	DESCRIÇÃO	EMBAL.
9437	30 cm	----
9434	40 cm	----
15148	50 cm	----
9435	60 cm	----
9436	80 cm	----

CABIDE INOX



CÓD.	DESCRIÇÃO	EMBAL.
9441	SIMPLES	----



ASSENTO SANIT. PLUS SLIM

CÓD. DESCRIÇÃO EMBAL.

15072	BEGE	C/04
15073	BRANCO	C/04
15074	CARAMELO	C/04
15075	CZ. CLARO	C/04
15076	PRETO	C/04



BRANCO CARAMELO CZ. CLARO PRETO

ASSENTO SANIT. SOFT

CÓD. DESCRIÇÃO EMBAL.

15068	BEGE	C/06
15069	BRANCO	C/06
15070	CARAMELO	C/06
15071	CZ. CLARO	C/06



BRANCO BEGE CINZA

ASSENTO SANIT. THEMA

CÓD. DESCRIÇÃO EMBAL.

15077	BRANCO	C/03
15078	CZ. CLARO	C/03
15079	PRETO	C/03



CINZA PRETO

CAIXA DESCARGA 6 A 9 LT

CÓD. DESCRIÇÃO EMBAL.

15062	BRANCO	C/06
15063	CARAMELO	C/06
15064	CZ. CLARO	C/06
15065	PRETO	C/06



CARAMELO CINZA PRETO

TORNEIRA BOIA P/ DESCARGA

CÓD. DESCRIÇÃO EMBAL.

15101	PRETO	C/06
-------	-------	------



R. São José, 508 - Centro - Areal-PB
(83) 3368-1121
ajalesatmc@hotmail.com



PARAFUSO PLAST. BR THEMA/MULTI/SLIM

CÓD.DESCRICÃO EMBAL.
15102 P/ASSENTO SANITARIO C/12PAR



PARAFUSO PLAST. BR NATURAL

CÓD.DESCRICÃO EMBAL.
15100 P/ASSENTO SANITARIO C/12PAR



TANQUE PLASTICO 15 LT 28x55x43CM

CÓD.DESCRICÃO EMBAL.
15066 BRANCO ----
15067 CZ. CLARO ----



ENGATE PLASTICO SUPER FLEX

CÓD.DESCRICÃO EMBAL.
15095 40 CM C/20
15096 50 CM C/20
15097 60 CM C/20



CANTONEIRA PLAST. P/ BANHEIRO 26X48CM

CÓD.DESCRICÃO EMBAL.
15081 BEGE C/06
15082 BRANCO C/06
15083 CARAMELO C/06
15084 CZ. CLARO C/06



CARAMELO



CINZA



BEGE

KIT ACESSORIO P/ BANHEIRO SOFT 5PÇS

CÓD.DESCRICÃO EMBAL.
15080 BRANCO C/06



R. São José, 508 - Centro - Areial-PB
(83) 3368-1121
ajalesatmc@hotmail.com



CAIXA COLETORA DE ÁGUA PLUVIAL PRETO

CÓD. DESCRIÇÃO EMBAL.
15086 24x20x24CM C/04



4,5 LT

CAIXA DE PASSAGEM E INSPEÇÃO DE ESG. PRETO

CÓD. DESCRIÇÃO EMBAL.
15087 24x20x24CM C/04



4,5 LT



REGISTRO ESFERA SOLDAVEL

CÓD.	BITOLA	EMBAL.
14720	1/2"	----
14722	3/4"	----
14721	1"	----
14723	1.1/4"	----
14724	1.1/2"	----



R. São José, 508 - Centro - Areial-PB
(83) 3368-1121
ajalesatmc@hotmail.com

INDUSPLAST

TUBO ELETRODUTO ROSCAVEL PVC

CÓD.	DESCRIÇÃO	EMBAL.
14727/ 15159	3/4"	C/30
14726/ 15160	1"	C/20



TUBO ELETRODUTO SOLD. C/ BOLSA

CÓD.	DESCRIÇÃO	EMBAL.
5155/ 15156	20mm	C/30
5154/ 15157	25mm	C/30
5156/ 15158	32mm	C/30



TUBO ESGOTO

CÓD.	DESCRIÇÃO	EMBAL.
7709/ 15155	40MM	----
7710/ 15154	50MM	----
7711/ 15153	75MM	----
7708/ 15152	100MM	----



INDUSPLAST

VIQUA

Nossa vida é água

ADAPTADOR FLANGE P/ CAIXA D'DAGUA

CÓD.	BITOLA	EMBAL.
8241	20X1/2"	C/05UN



IRRIGADOR GIRATÓRIO

CÓD.	DESCRIÇÃO	EMBAL.
7713	C/ ESTACA	----



REGISTRO ESFERA SOLDÁVEL

CÓD.	BITOLA	EMBAL.
7395	20mm	C/05UN
7399	25mm	C/05UN
7396	32mm	C/05UN
7397	40mm	C/05UN
7398	50mm	C/02UN



KIT REPARO 1/4 VOLTA

CÓD.	DESCRIÇÃO	EMBAL.
10934	CERAMICO	----



R. São José, 508 - Centro - Areal-PB
(83) 3368-1121
ajalesatmc@hotmail.com